

WARNING:

- This product must be installed in accordance with the applicable installation code by a person familiar with the construction and operation of the product and the hazards involved.
- Make sure all electrical power is turned off while installing the fixture.
- This luminaire must be adequately grounded for protection against shock hazards and to assure proper operation.

- Disconnect power before servicing.
- LEDs are ESD (Electro Static Discharge) sensitive devices that can be easily damaged if the proper ESD mitigating steps are not taken.
- LEDs are very sensitive to mechanical damage. Caution must be taken to avoid damage to the LEDs.
- ESD or mechanical damage voids all warranties.

TABLE OF CONTENTS

| | | | |
|--|---|---|---|
| A. GAT MOUNTING BRACKET ASSEMBLY | 1 | E. ROW MOUNT ASSEMBLY | 2 |
| B. MOUNTING DIMENSIONS | 1 | F. LENS INSTALLATION..... | 3 |
| C. MOUNT CANOPY TO JUNCTION BOX..... | 2 | G. 45AMB INSTALLATION (SURFACE MOUNT ONLY)..... | 3 |
| D. STAND-ALONE ASSEMBLY | 2 | | |

A. GAT MOUNTING BRACKET ASSEMBLY (FOR T-BAR CEILING ONLY)

STEP 1: T-bar mounting bracket halves are supplied as a one-piece metal stamping. Bend inward at middle until bracket breaks into two pieces.

FIG A.1.1

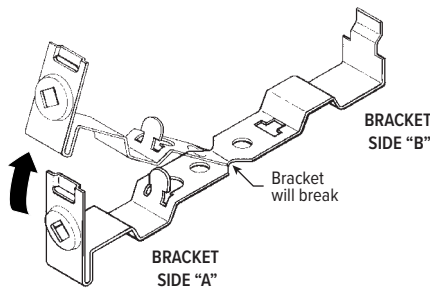

STEP 2: Insert 1/4 - 20 threaded stud into "A" half of bracket.

FIG A.2.1

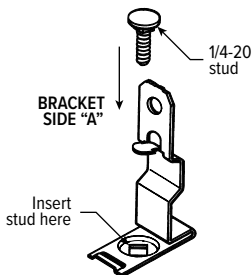

STEP 3: T-bar mounting bracket halves interlock and snap together around T-bar. Brackets must be placed exactly on each mounting point for correct installation and hanging of cables.

FIG A.3.1

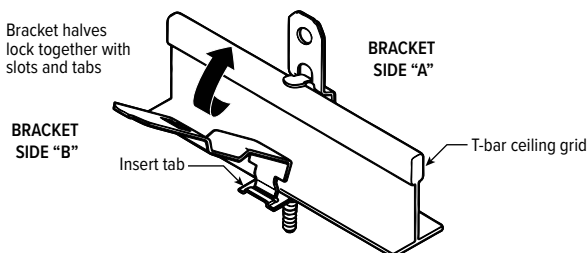

B. MOUNTING DIMENSIONS

STEP 1: SUSPENDED INSTALLATION: Place mounting points at the dimensions specified below.
SURFACE MOUNT INSTALLATION: Secure the fixture to the ceiling structure using adequate hardware (by others)

FIG B.1.1 Fixture Backview

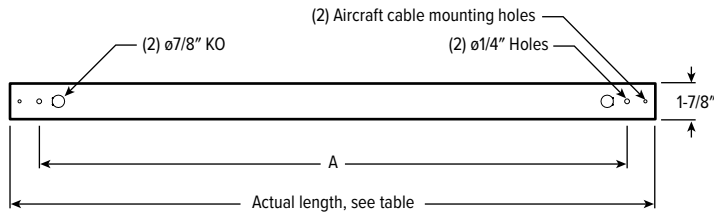

| | ACTUAL LENGTH | A |
|----|---------------|-----------|
| 2' | 24-5/16" | 23-5/16" |
| 4' | 46-7/16" | 45-7/16" |
| 8' | 92-15/16" | 91-15/16" |

FIG B.1.2 Center-To-Center Mounting Cable Detail (Suspended Mount Only)

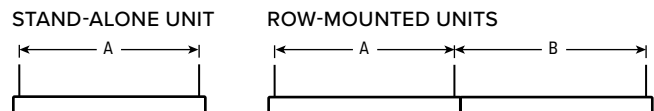

| | A | B |
|----|---------|---------|
| 2' | 23-1/4" | 24-1/4" |
| 4' | 45-3/8" | 46-3/8" |
| 8' | 91-3/4" | 92-3/4" |

FOR SUSPENDED INSTALLATION, PROCEED TO "MOUNT CANOPY TO JUNCTION BOX" ON PAGE 2.

FOR SURFACE MOUNT INSTALLATION, PROCEED TO "STEP 3: ALIGN ROWS" ON PAGE 2.

LLM LED

INSTALLATION INSTRUCTIONS

C. MOUNT CANOPY TO JUNCTION BOX

FIG C.1.4

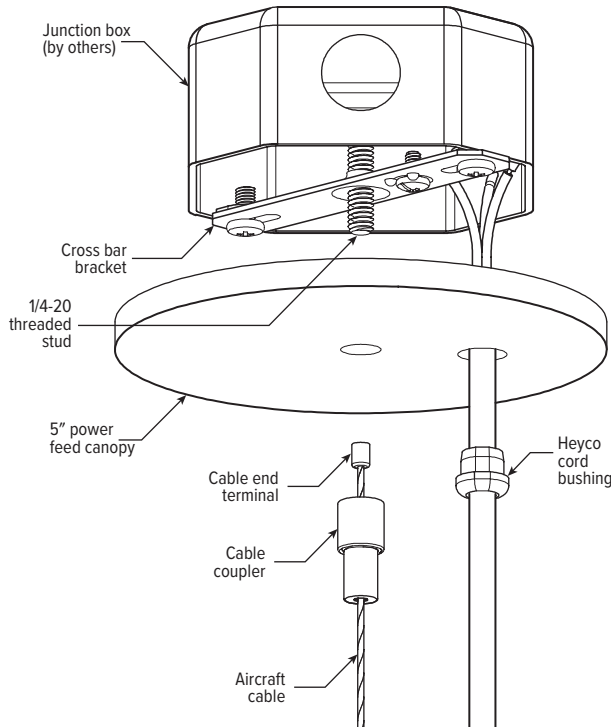

- STEP 1:** Mount the cross bar bracket to the junction box.
- STEP 2:** Insert the 1/4-20 stud into the cross bar.
- STEP 3:** Holding luminaire in place, make electrical connections.
- STEP 4:** Place the canopy cover with the 1/4-20 stud, centered.
- STEP 5:** Raise luminaire and thread cable coupler onto the 1/4-20 stud.
- NOTE:**

- 2 inch non-feed canopy supplied for opposite end.
- No junction box required for 2" canopy.
- Only 1/4-20 threaded material needed for non-feed mounting.
- Repeat steps 4 and 5 for non-feed mounting point.

D. STAND-ALONE ASSEMBLY

- STEP 1:** A stand-alone fixture will require two suspension cables. For safety, always support the weight of the fixture.
- Do not leave a fixture hanging by only one end while working.**

FIG D.1.1

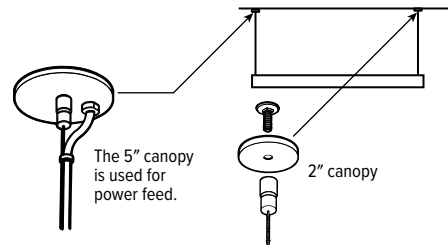

E. ROW MOUNT ASSEMBLY

FIG E.1.2

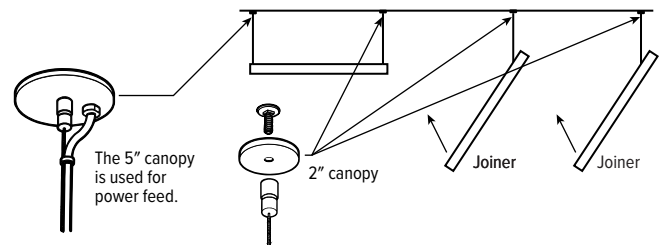

- STEP 1: START A ROW**
- Only the first fixture in each row will require two suspension points. Each adjoining fixture will require only one suspension point before attaching to the previous fixture.
- NOTE:** For safety, always support the weight of the fixture.
Do not leave a fixture hanging by only one end while working.

STEP 2: HANG & CONNECT ROWS

- A. Begin each row by hanging & leveling the power feed fixture from the first two suspension cables.
- B. The second fixture in line will hang from the following suspension cable and attach to the end of the first fixture.
- C. Plug fixtures together with quick-connect wiring at fixture ends.

STEP 3: ALIGN ROWS

- A. Line-up holes in row-aligner and center end plate with pem studs in channel, using nuts to secure in fixture. Repeat to completion of row.

FIG E.3.1

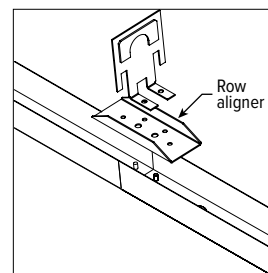

LLM LED

INSTALLATION INSTRUCTIONS

F. LENS INSTALLATION

FIG F.3.2 Install Lens

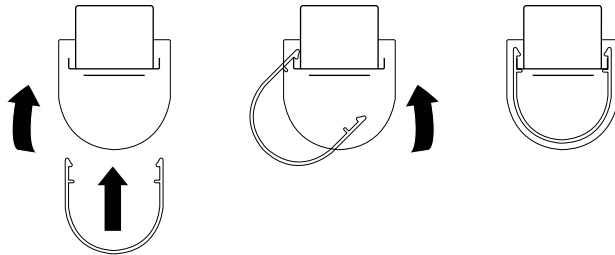
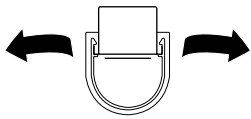
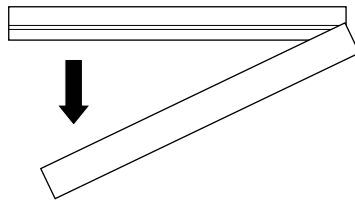

FIG F.3.3 Remove Lens

A. Gently pull both sides outward on one end of the fixture.



B. Start at one end of the fixture then pull the entire lens off.



G. 45AMB INSTALLATION (SURFACE MOUNT ONLY)

Field-adjustable up and down in 7-1/2° increments.

FIG G.3.4 ANGLE ADJUSTMENT

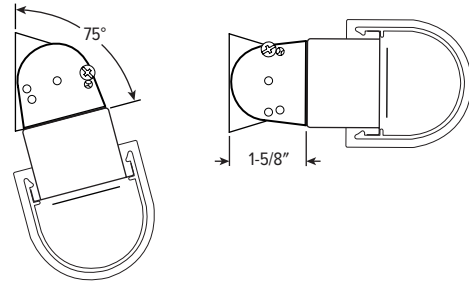
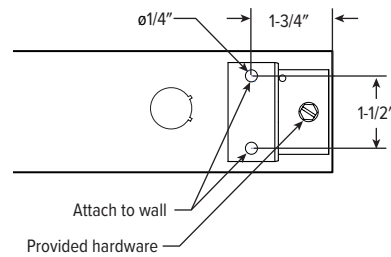

FIG G.3.5 BACKVIEW



STEP 1: Attach brackets to back of fixture in orientation shown with provided hardware. See FIG G.3.5.

STEP 2: Using attached brackets as a guide, mark holes and attach to wall. (Hardware by others). See FIG G.3.5.

STEP 3: Adjust fixture to desired angle and lock using provided #8 screws. See FIG G.3.4

STEP 4: Make electrical connections in accordance with NEC and local codes.