

2AS LED 2" Adjustable Downlight – Square

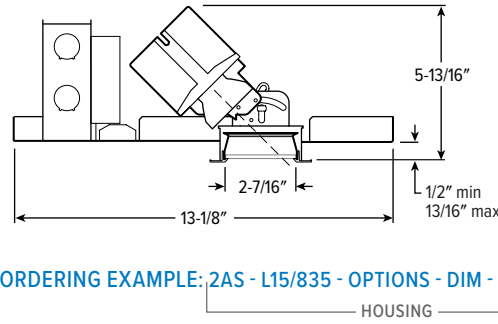
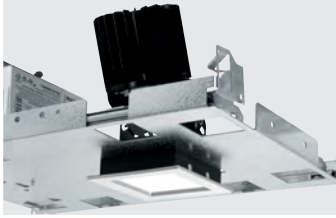

CATALOG #: _____

TYPE: _____

PROJECT: _____

NEW CONSTRUCTION AND REMODEL

FEATURES

- 2" aperture is unobtrusive in small scale spaces
- Adjustable aim with 0° - 45° tilt and 360° rotation
- Zero-flange trim options for modern ceiling
- Die cast trim choices include flush or regressed lens

SPECIFICATIONS

- HOUSING** – Die-cast aluminum spun and stamped articulating mechanism with forged aluminum heat sink. Galvanized steel splice compartment with driver mounting plate/enclosure. Mounting clips allow for ceiling thickness from 1/2" – 13/16".
- LENSED TRIM** – Die-cast aluminum frame with micro-prismatic, tempered glass lens.
- ELECTRICAL** – High-performance Class 2 C.O.B. LED array. Modular quick-connect plug for easy field-connection of LED light assembly to driver. Reported L70>55,000 hours. Reported L90>55,000 hours. Estimated L70 = 200,000 hours.
- MOUNTING** – Recessed. 20 ga. galvanized steel mounting pan for new construction or IC-rated enclosure. N and R mounting types for use in non-fire rated installations only. Minimum 13-1/4" O.C. marked spacing required for L12 and L15 lumen packages when specified with R Mounting Type.
- LISTINGS** –
 - cCSAus conforms to UL STD 1598; Certified to CAN/CSA STD C22.2 No. 250.0 for damp locations. LED light assembly conforms to UL 2108 for remote installation.
 - Suitable for wet location under covered ceiling when specified with WET/CC option.
 - IC-rated for direct contact with insulation when specified with I Mounting Type.
 - City of Chicago Environmental Air approved when specified with CP option.
 - Complies with ASTM-E283 when specified with ATH option.
 - RoHS compliant.
- WARRANTY** – 5-year limited warranty, see hew.com/warranty.

ORDERING EXAMPLE: 2AS - L15/835 - OPTIONS - DIM - UNV - LW - OF - CS - TRIM OPTIONS - N - F1

HOUSING

SERIES	LUMENS ^[1]	CRI	CCT	OPTIONS	CONTROL ^[2]	VOLTAGE
2AS	L5 500lm	8 80	27 2700K	EM/5W 5-watt emergency battery ^[4]	DIM Dimming driver, 0-10V	UNV 120-277V 347 347V ^[12]
	L7 700lm	9 90 ^[3]	30 3000K	EM/7W 7-watt emergency battery ^[5]		
	L9 900lm		35 3500K	EM/10W 10-watt emergency battery ^[6]	DIM1 1% Dimming driver, 0-10V ^[11]	
	L12 1,200lm		40 4000K	EM/10W/RTS 10-watt emergency battery with regressed test switch ^[7]		
	L15 1,500lm		50 5000K	ATH Airtight construction ^[8]		
			F Fuse			
			CP Chicago plenum (CCEA) ^[9]			
			SDT Stepdown transformer ^[10]			

TRIM^[13]

TRIM TYPE	DISTRIBUTION ^[14]	FLANGE TYPE	REFLECTOR FINISH	TRIM OPTIONS
L Flush lens	W 35° Wide	OF 1/2" standard flange	CS Clear semi-specular powder coat	AD Diffuse acrylic lens ^[16]
R Regressed lens	M 20° Medium	ZF Zero-flange mud-in ^[15]	WH White texture powder coat	PD Diffuse 1/8" polycarbonate lens
	N 15° Narrow		BL Black texture powder coat	WET/CC Wet location, covered ceiling listed
				AM Anti-microbial ^[17]

MOUNTING

MOUNTING TYPE^[18]

- N Open pan for new construction^[20]
- I IC-rated enclosure for new construction^[21]
- R Remodel kit^[22]

MOUNTING HARDWARE^[19]

- F1 Integral 2-position fixed pan bracket, universal bar hanger included^[23]
- BA1 Adjustable butterfly pan bracket, bar hanger not included^[24]
- CA1 Adjustable caterpillar pan bracket, universal bar hanger included^[25]

NOTES

- Lumen output based on L trim type, W distribution and WH finish, 3500K/80CRI. Actual lumens may vary +/-5%, see page 2 for FIXTURE PERFORMANCE DATA
- See page 3 for ADDITIONAL CONTROL OPTIONS.
- Not available with 5000K CCT. Extended lead times may apply. Consult factory for availability.
- N and R Mounting Types only.
- N and R Mounting Types only.
- Not available with L5 lumen package. N and R Mounting Types only.
- Not available with L5 lumen package, WET/CC or ATH options. N Mounting Type only. Top access required. See page 4 for EM BATTERY DETAILS.
- I Mounting Type required.
- I Mounting Type required.
- May be required for 347V, see product builder at hew.com/product-builder

- L9 minimum lumen package required
- Not available with EM batteries or DMX controls.
- Trim ships separately.
- Beam angle based on L Trim Type and WH Reflector Finish. Trim Type affects beam angle. See page 2 for FIXTURE PERFORMANCE DATA.
- For use with mud-in plaster construction only, supplied with mud flange installation kit. See page 3 for TRIM TYPE DETAILS. Not available with ATH or WET/CC options.
- W distribution only.
- WH and BL Reflector Finishes only.
- Mounting hardware required (N and I only), ordered separately, see MOUNTING HARDWARE ordering info. See page 4 for MOUNTING TYPE DETAILS.

- Additional mounting hardware options available. See page 5 for MOUNTING HARDWARE DETAILS.
- Top access required for driver maintenance.
- L9 lumen package max. Top access required for driver maintenance.
- Also used in new construction sheetrock ceilings. Additional plenum space required for R mounting when specified with EM battery. See page 4 for EM BATTERY DETAILS.
- N and I Mounting Types only. I Mounting requires external brackets
- N Mounting Type only
- N Mounting Type only

2AS LED 2" Adjustable Downlight – Square

FIXTURE PERFORMANCE DATA

DISTRIBUTION	WATTAGE	FLUSH LENS TRIM TYPE		REGRESSED LENS TRIM TYPE		
		DELIVERED LUMENS	EFFICACY (lm/W)	DELIVERED LUMENS	EFFICACY (lm/W)	
L5	W	8.2	503	61	480	59
	M	8.2	408	50	372	45
	N	8.2	463	56	449	55
L7	W	11.5	714	62	681	59
	M	11.5	578	50	527	46
	N	11.5	656	57	636	55
L9	W	14.5	885	61	845	58
	M	14.5	717	49	654	45
	N	14.5	814	56	789	54
L12	W	21.3	1179	55	1125	53
	M	21.3	955	45	871	41
	N	21.3	1084	51	1051	49
L15	W	27.9	1331	48	1270	46
	M	27.9	1078	39	983	35
	N	27.9	1224	44	1187	43

- Photometrics tested in accordance with IESNA LM-79. Results shown are based on 25°C ambient temperature.
- Wattage shown is based on 120V input.
- Results based on 3500K, 80 CRI, actual lumens may vary +/-5%
- Beam angle based on L Trim Type and WH Reflector Finish.
- Use multiplier tables to calculate additional options.

MULTIPLIER TABLES

	COLOR TEMPERATURE	
	CCT	CONVERSION FACTOR
80 CRI	2700K	0.92
	3000K	0.98
	3500K	1.00
	4000K	1.01
90 CRI	2700K	0.76
	3000K	0.79
	3500K	0.82
	4000K	0.84

REFLECTOR FINISH	
CATALOG NUMBER	CONVERSION FACTOR
WH	1.00
CS	0.98
BL	0.79

TRIM OPTIONS	
CATALOG NUMBER	CONVERSION FACTOR
AD	0.85
PD	0.85

BEAM ANGLE

	TRIM TYPE	
	FLUSH	REGRESSED
W	35°	35°
M	20°	20°
N	15°	15°

PHOTOMETRY

2AS-L12/835-DIM-UNV-LW-OF-WH 0° TILT Report #: 13257190; 03/19/20 | Total Luminaire Output: 1179 lumens; 21.3 Watts | Efficacy: 55.4 lm/W | 80 CRI; 3500K CCT

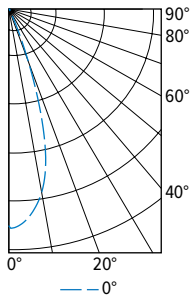

CANDLEPOWER DISTRIBUTION	VERTICAL ANGLE	HORIZONTAL ANGLE	ZONAL LUMENS
		0°	
	0	3527	
	5	3424	227
	15	2151	269
	25	179	47
	35	30	11
	45	24	10
	55	24	11
	65	20	9
	75	12	5
	85	3	1
	90	0	

LUMEN SUMMARY	ZONE	LUMENS	% FIXTURE
	0 - 40	1101	93
	0 - 60	1144	97
	0 - 90	1179	100
	0-180	1179	100

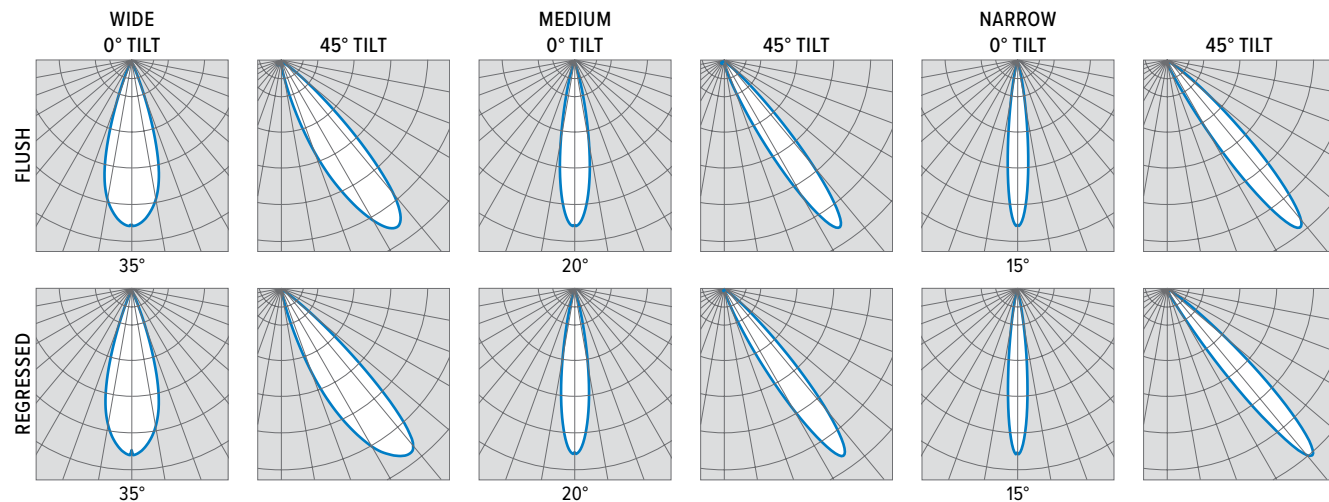

2AS^{LED} 2" Adjustable Downlight – Square

ADDITIONAL CONTROL OPTIONS

347V may require stepdown transformer, see product builder at hew.com/product-builder. R Mounting Type only available with DIM, DIM1, and DIM LINE controls.

CATALOG NUMBER	DESCRIPTION
DIM	Dimming driver prewired for 0-10V low voltage applications
DIM1	1% dimming driver prewired for 0-10V low voltage applications
DIM LINE	Line voltage dimming driver (TRIAC and ELV compatible at 120V only)
DMX	0.1% dimming driver for DMX controls
LTE LINE	Lutron Hi-lume 1% 2-wire dimming driver forward phase line voltage controls (120V only)
LDE1	Lutron Hi-lume 1% EcoSystem dimming LED driver
LDE5	Lutron 5-Series 5% EcoSystem dimming LED driver
VRF/DSR	Lutron Vive integral fixture control, RF only (DFCSJ-OEM-RF) and sensor-ready driver
VRF/DBI/LDE1	Lutron Vive integral fixture control, RF only (DFCSJ-OEM-RF), Lutron Hi-lume 1% EcoSystem dimming LED driver, and digital link interface
VRF/DBI/LDE5	Lutron Vive integral fixture control, RF only (DFCSJ-OEM-RF), Lutron 5-Series 5% EcoSystem dimming LED driver, and digital link interface
FCJS/DIM	Lutron Vive PowPak wireless fixture control with dimming driver
FCJS/DIM1	Lutron Vive PowPak wireless fixture control with 1% dimming driver
ELDO SOLOB	EldoLED Solodrive, 0.1% dimming driver for 0-10V controls
ELDO SOLOB DALI	EldoLED Solodrive, 0.1% dimming driver for DALI controls
ELDO ECO1	EldoLED Ecodrive, 1% dimming driver for 0-10V controls
ELDO ECO1 DALI	EldoLED Ecodrive, 1% dimming driver for DALI controls

TRIM TYPE DETAILS

1/2" STANDARD FLANGE TYPE

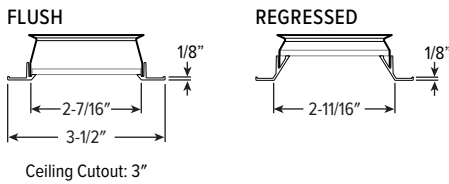

ZERO-FLANGE MUD-IN

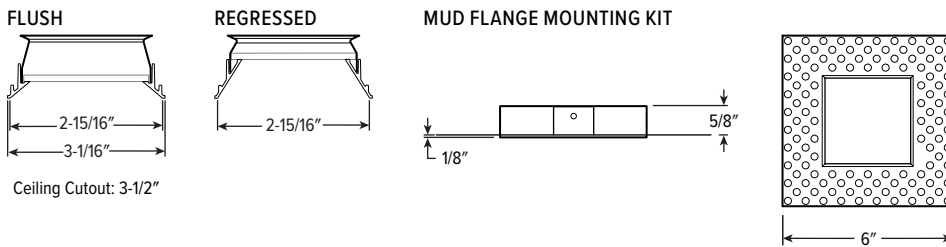

REFLECTOR FINISH DETAILS

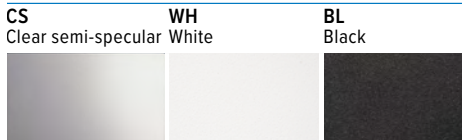

2AS^{LED} 2" Adjustable Downlight – Square

MOUNTING TYPE DETAILS

NEW CONSTRUCTION

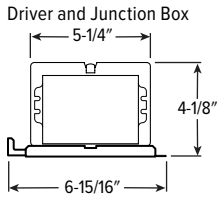
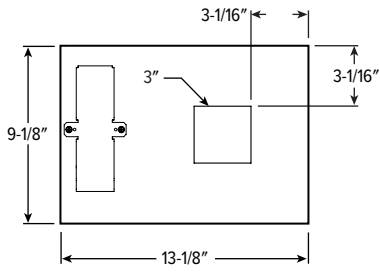

IC-RATED

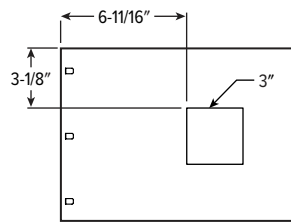
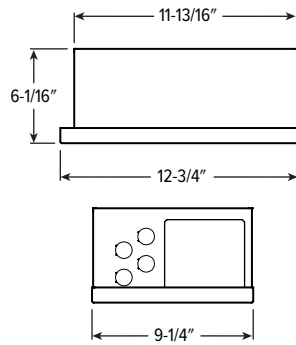

REMODEL

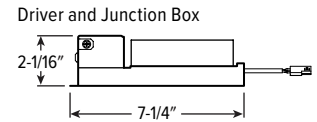
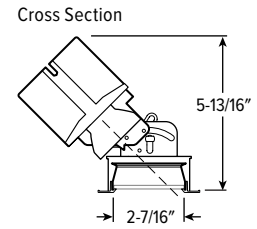

EM BATTERY DETAILS

REMODEL MOUNTING

Additional plenum space required for R mounting when specified with EM battery.

PLENUM RESTRICTIONS	
CATALOG NUMBER	MINIMUM HEIGHT
EM/5W	7"
EM/7W	9"
EM/10W	11"

EM/10W/RTS MOUNTING

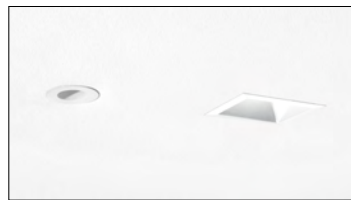

Shown Installed

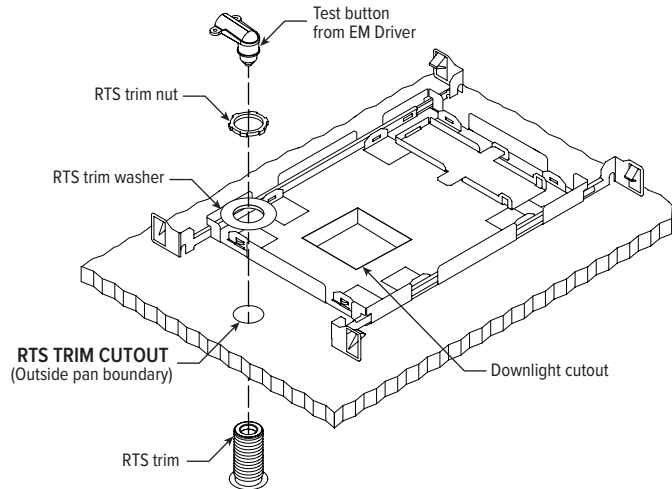

2AS^{LED} 2" Adjustable Downlight – Square

MOUNTING HARDWARE DETAILS

F1 Integral 2-position fixed pan bracket, universal bar hanger included

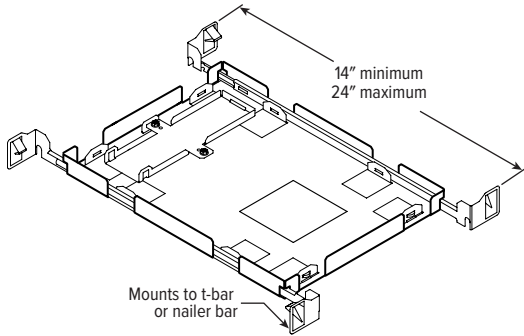

BA1 Adjustable butterfly pan bracket, bar hanger not included (N Mounting Type only)

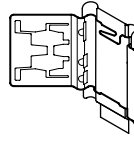

CA1 Adjustable caterpillar pan bracket, universal bar hanger included (N Mounting Type only)

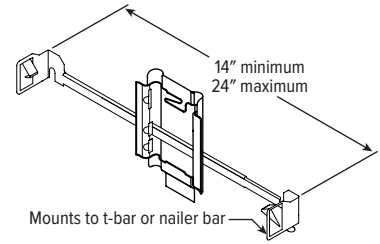

BA2 Adjustable butterfly pan bracket, heavy-duty universal bar hanger included (N Mounting Type only)

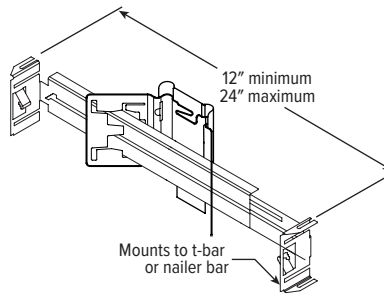

CA2 Adjustable caterpillar pan bracket, t-bar hanger included (N Mounting Type only)

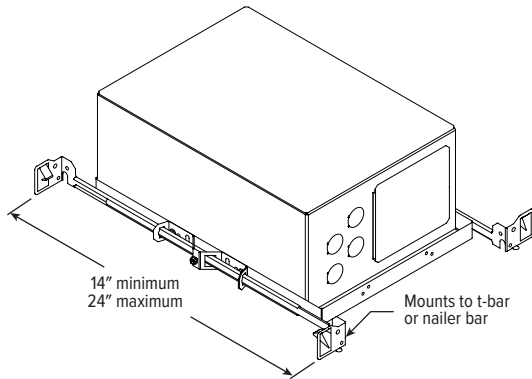
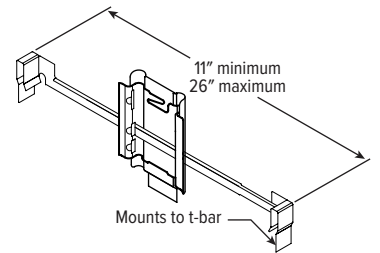

F1 with I Mounting Type

