

4AR tunable **WHITE** 4.5" Adjustable Downlight – Round

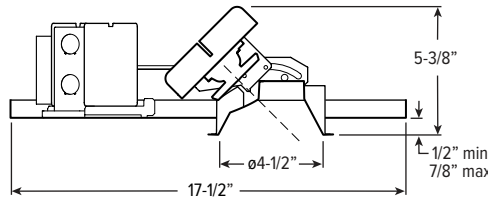

CATALOG #: _____

TYPE: _____

PROJECT: _____

NEW CONSTRUCTION AND REMODEL

FEATURES

- Tunable white from 2700K to 5000K CCT, minimum 80 CRI
- Adjustable aim with 0° - 45° tilt and 360° rotation
- Etched degree markers and directional indicator make it simple to fine-tune the illumination angle
- 4 inch aperture is unobtrusive in small scale spaces
- Spring clip retention system eliminates trim sag
- Choice of open reflector or die-cast lensed trims to complement interior style
- Contemporary design provides glare-free illumination for a soft ceiling appearance
- Fully room-side accessible

SPECIFICATIONS

- HOUSING** – Die-cast aluminum spun and stamped articulating mechanism with forged aluminum heat sink. Galvanized steel splice compartment with driver mounting plate/enclosure. Mounting clips allow for ceiling thickness from 1/2" - 7/8".
- OPEN REFLECTOR** – Low-iridescent anodized aluminum. Clear semi-specular finish standard.
- LENSED TRIM** – Die-cast aluminum frame with micro-prismatic, tempered glass lens.
- ELECTRICAL** – High-performance Class 2 LED array. Modular quick-connect plug for easy field-connection of LED light assembly to driver. Reported L70>50,000 hours. Tunable White products use LEDs of multiple CCTs and may produce a perceptibly different shade of white from single-CCT products at the same CCT. All CCTs are within 3 MacAdam ellipses.
- MOUNTING** – Recessed. 20 ga. galvanized steel mounting pan for new construction or IC-rated enclosure. Remodel kit option includes receiver bracket hardware. N and R mounting types for use in non-fire rated installations only.
- LISTINGS** –
 - cCSAus conforms to UL STD 1598; Certified to CAN/CSA STD C22.2 No. 250.0 for damp locations. LED light assembly conforms to UL 2108 for remote installation.
 - Suitable for wet location under covered ceiling when specified with WET/CC option.
 - IC-rated for direct contact with insulation when specified with I Mounting Type.
 - City of Chicago Environmental Air approved when specified with CP option.
 - Complies with ASTM-E283 when specified with ATH option.
 - RoHS compliant.
- WARRANTY** – 5-year limited warranty, see [hew.com/warranty](http://www.hew.com/warranty).

ORDERING EXAMPLE: **4AR - L11/8TW - OPTIONS - DIM - UNV - OW - OF - CS - TRIM OPTIONS - N - F1**

HOUSING TRIM MOUNT.

HOUSING

SERIES	LUMENS ^[1]	COLOR	OPTIONS	CONTROL	VOLTAGE
4AR	L11 1,100lm	8TW Tunable white (80 CRI, 2700K-5000K)	EM/7W	7-watt emergency battery ^[2]	DALI Driver prewired for DALI applications
	L16 1,600lm		EM/10W	10-watt emergency battery ^[3]	
			EM/10W/RTS	10-watt emergency battery with regressed test switch ^[4]	DIM Dimming driver with (1) 0-10V signal to control dimming and (1) 0-10V signal to control CCT
			ATH	Airtight construction ^[5]	
			CP	Chicago plenum (CCEA) ^[6]	
		F	Fuse kit	DMX Driver prewired for DMX applications	

TRIM ^[7]

TRIM TYPE	DISTRIBUTION ^[8]	FLANGE TYPE	REFLECTOR FINISH	TRIM OPTIONS
O Open reflector	W Wide	OF 1/2" standard flange	Open trim types	MWT Textured white trim flange ^[11]
L Flush lens	45° Open	SF 1/4" mud-in flange ^[10]	CS Clear semi-specular anodize	AD Diffuse acrylic lens ^[12]
A Angled lens	40° Flush		WH White texture powder coat	PD Diffuse 1/8" polycarbonate lens ^[13]
	30° Angled		BL Black texture powder coat	WET/CC Wet location, covered ceiling listed ^[14]
	M Medium		Lens trim types	AM Anti-microbial ^[15]
	30° Open		CS Clear semi-specular powder coat	
	30° Flush		WH White texture powder coat	
	25° Angled		BL Black texture powder coat	
	N Narrow ^[9]			
	25° Flush			
	25° Angled			

MOUNTING

MOUNTING TYPE ^[16]

- N Open pan for new construction
- I IC-rated enclosure for new construction
- R Remodel kit ^[18]

MOUNTING HARDWARE ^[17]

- F1 Factory-installed 2-position fixed pan bracket, universal bar hanger included ^[19]
- BA1 Adjustable butterfly pan bracket, bar hanger not included ^[20]
- CA1 Adjustable caterpillar pan bracket, universal bar hanger included ^[21]

NOTES

- Lumen output based on O trim type, M distribution and CS finish, 4000K/80CRI. Actual lumens may vary +/-5%, see page 2 for FIXTURE PERFORMANCE DATA
- N and R Mounting Types only.
- N and R Mounting Types only.
- Not available with WET/CC or ATH options. N and R Mounting Types only. See page 4 for EM/10W/RTS DETAILS.
- I Mounting Type required.
- I Mounting Type required.
- Trim ships separately
- Beam angle based on CS or WH reflector finish.
- L and A Trim Types only.
- For use with mud-in plaster construction only, supplied with mud flange installation kit. See page 3 for FLANGE TYPE DETAILS.
- Not available with ATH option

- Not available with WH Reflector Finish or L Trim Type.
- L and A Trim Types only. W distribution only.
- L and A Trim Types only. W distribution only.
- L Trim Type only.
- WH and BL Reflector Finishes only.
- Mounting hardware required (N and I only), ordered separately, see MOUNTING HARDWARE ordering info. See page 4 for MOUNTING TYPE DETAILS.
- Additional mounting hardware options available. See page 5 for MOUNTING HARDWARE DETAILS.
- Also used in new construction sheet rock ceilings.
- N and I Mounting Types only. Universal bar hanger ships uninstalled
- N Mounting Type only
- N Mounting Type only



4AR tunable WHITE

4.5" Adjustable Downlight – Round

FIXTURE PERFORMANCE DATA

OPEN REFLECTOR TRIM TYPE

	DISTRIBUTION	DELIVERED LUMENS	WATTAGE	EFFICACY (lm/W)
L11	W	713	14.6	49.0
	M	990	14.6	68.0
	N	-	-	-
L16	W	1231	24.0	51.2
	M	1652	24.0	68.7
	N	-	-	-

FLUSH LENS TRIM TYPE

	DISTRIBUTION	DELIVERED LUMENS	WATTAGE	EFFICACY (lm/W)
L11	W	710	14.6	45.8
	M	960	14.6	61.2
	N	965	14.6	66.1
L16	W	1266	24.0	46.8
	M	1650	24.0	61.8
	N	1643	24.0	66.3

- Photometrics tested in accordance with IESNA LM-79. Results shown are based on 25°C ambient temperature.
- Wattage shown is based on 120V input.
- Results based on 4000K, 80 CRI, 0° tilt, actual lumens may vary +/-5%
- Use multiplier tables to calculate additional options.

ANGLED LENS TRIM TYPE

	DISTRIBUTION	DELIVERED LUMENS	WATTAGE	EFFICACY (lm/W)
L11	W	506	14.6	36.6
	M	741	14.6	50.9
	N	900	14.6	62.2
L16	W	923	24.0	37.3
	M	1261	24.0	55.1
	N	1416	24.0	59.6

MULTIPLIER TABLES

COLOR TEMPERATURE		
CCT	LUMENS	WATTS
2700K	0.83	1.03
3000K	1.00	1.00
3500K	0.99	0.99
4000K	1.00	1.00
5000K	0.98	1.03

OPEN REFLECTOR FINISH	
CATALOG NUMBER	CONVERSION FACTOR
CS	1.00
WH	0.89
BL	0.79

TRIM	
CATALOG NUMBER	CONVERSION FACTOR
AD ¹	0.85
PD ¹	0.85

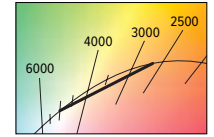

¹ Distribution will also be affected, consult factory.

PHOTOMETRY

4AR-L11/8TW-DIM-UNV-OW-OF-CS (25° tilt) Total Luminaire Output: 778 lumens; 14.6 Watts | Efficacy: 53.3 lm/W | 80 CRI; 4037K CCT

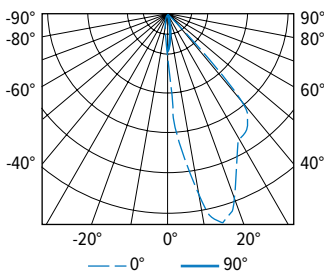

VERTICAL ANGLE	HORIZONTAL ANGLE					ZONAL LUMENS
	0°	45°	90°	135°	180°	
0	452	452	452	452	452	
5	1372	962	375	155	112	56
15	2482	1356	145	35	23	183
25	1869	1235	37	10	8	244
35	1618	569	7	4	6	229
45	334	17	3	2	2	64
55	3	0	0	0	0	1
65	1	0	0	0	0	0
75	0	0	0	0	0	0
85	0	0	0	0	0	0
90	0	0	0	0	0	0

LUMEN SUMMARY	ZONE	LUMENS	% FIXTURE
	0 - 40	483	62
	0 - 60	712	91
	0 - 90	778	100
	0 - 180	778	100

4AR-L11/8TW-DIM-UNV-OM-OF-CS (25° tilt) Total Luminaire Output: 963 lumens; 14.6 Watts | Efficacy: 66.0 lm/W | 80 CRI; 4037K CCT

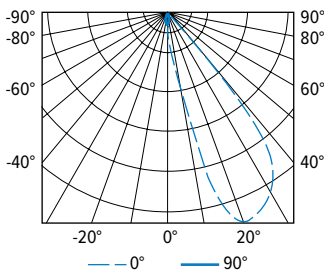

VERTICAL ANGLE	HORIZONTAL ANGLE					ZONAL LUMENS
	0°	45°	90°	135°	180°	
0	236	236	236	236	236	
5	670	446	209	113	92	32
15	3376	832	105	35	20	191
25	3867	846	40	7	6	356
35	3195	363	6	0	0	321
45	368	18	0	0	0	63
55	3	0	0	0	0	1
65	0	0	0	0	0	0
75	0	0	0	0	0	0
85	0	0	0	0	0	0
90	0	0	0	0	0	0

LUMEN SUMMARY	ZONE	LUMENS	% FIXTURE
	0 - 40	899	93
	0 - 60	963	100
	0 - 90	963	100
	0 - 180	963	100

4AR-L11/8TW-DIM-UNV-LN-OF-WH (25° tilt) Total Luminaire Output: 965 lumens; 14.6 Watts | Efficacy: 66.1 lm/W | 80 CRI; 4037K CCT

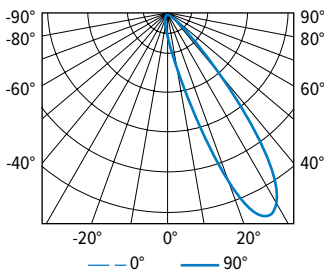

VERTICAL ANGLE	HORIZONTAL ANGLE					ZONAL LUMENS
	0°	45°	90°	135°	180°	
0	163	163	163	163	163	
5	466	354	159	81	69	24
15	2021	781	98	38	37	142
25	3635	832	46	31	34	315
35	2643	420	22	24	29	291
45	770	113	14	22	30	129
55	188	30	10	19	28	41
65	32	12	7	14	21	16
75	9	4	3	6	11	6
85	0	0	0	0	0	1
90	0	0	0	0	0	0

LUMEN SUMMARY	ZONE	LUMENS	% FIXTURE
	0 - 40	772	80
	0 - 60	942	98
	0 - 90	965	100
	0 - 180	965	100



4AR tunable WHITE 4.5" Adjustable Downlight – Round

4AR-L11/8TW-DIM-UNV-LM-OF-WH (25° tilt) Total Luminaire Output: 929 lumens; 14.6 Watts | Efficacy: 63.6 lm/W | 80 CRI; 4037K CCT

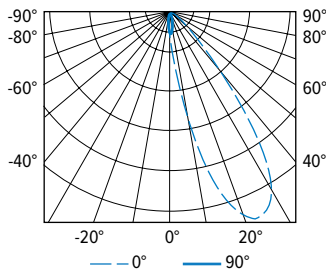

CANDLEPOWER DISTRIBUTION	VERTICAL ANGLE	HORIZONTAL ANGLE					ZONAL LUMENS
		0°	45°	90°	135°	180°	
	0	284	284	284	284	284	
	5	703	539	267	146	118	36
	15	2286	990	164	65	56	169
	25	2983	958	77	45	49	299
	35	1957	423	40	45	55	247
	45	548	105	29	46	59	106
	55	98	31	22	38	49	41
	65	24	13	13	25	33	21
	75	9	5	6	11	16	9
	85	1	0	0	0	1	1
	90	0	0	0	0	0	

LUMEN SUMMARY	ZONE	LUMENS	% FIXTURE
	0 - 40	751	81
	0 - 60	898	97
	0 - 90	929	100
	0 - 180	929	100

4AR-L11/8TW-DIM-UNV-AM-OF-WH (25° tilt) Total Luminaire Output: 780 lumens; 14.6 Watts | Efficacy: 53.4 lm/W | 80 CRI; 4037K CCT

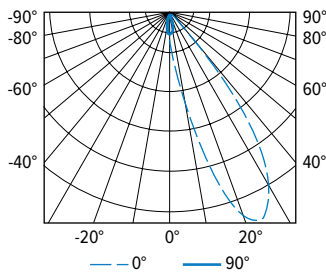

CANDLEPOWER DISTRIBUTION	VERTICAL ANGLE	HORIZONTAL ANGLE					ZONAL LUMENS
		0°	45°	90°	135°	180°	
	0	253	253	253	253	253	
	5	651	451	243	128	92	32
	15	2198	919	141	43	29	157
	25	3001	830	53	21	18	279
	35	1894	304	24	22	24	216
	45	384	54	18	21	23	71
	55	38	12	13	15	15	17
	65	10	7	6	6	4	6
	75	3	2	0	0	1	1
	85	0	0	0	0	0	0
	90	0	0	0	0	0	

LUMEN SUMMARY	ZONE	LUMENS	% FIXTURE
	0 - 40	684	88
	0 - 60	772	99
	0 - 90	780	100
	0 - 180	780	100

TRIM TYPE DETAILS

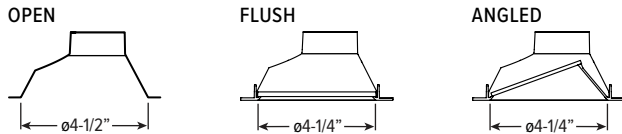

FLANGE TYPE DETAILS

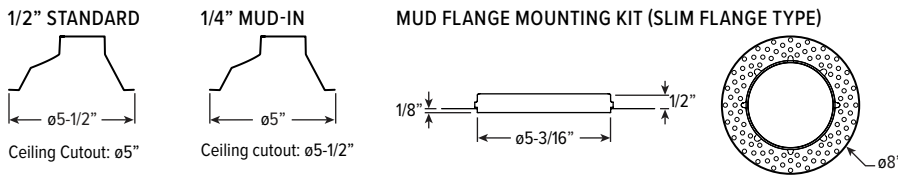

REFLECTOR FINISH DETAILS

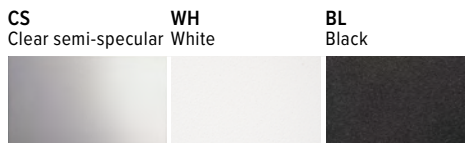

4AR tunable WHITE

4.5" Adjustable Downlight – Round

MOUNTING TYPE DETAILS

NEW CONSTRUCTION

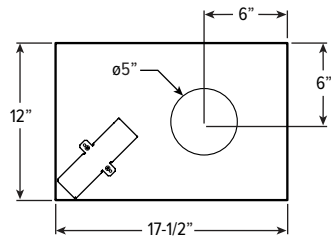

IC-RATED

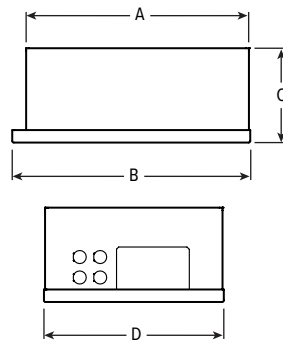

LENGTH			
A	B	C	D
15-3/16"	16"	6-3/8"	12-1/8"

REMODEL

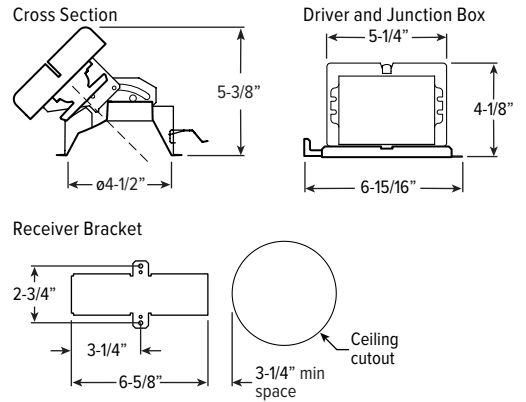

EM/10W/RTS DETAILS

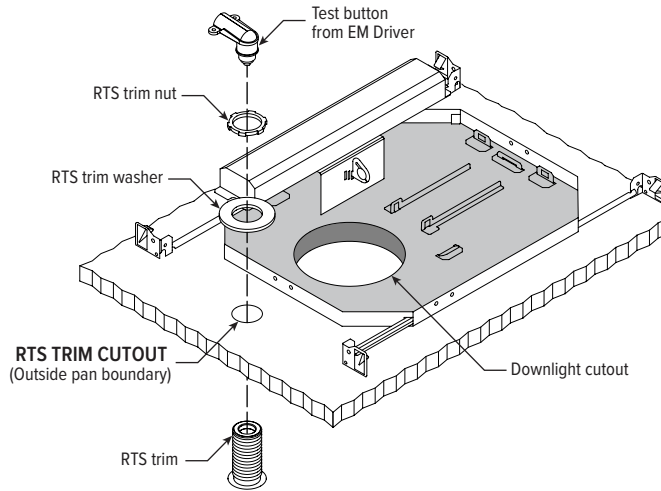
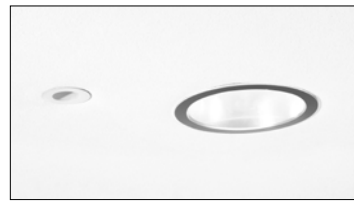

4AR tunable WHITE

4.5" Adjustable Downlight – Round

MOUNTING HARDWARE DETAILS

F1 Factory-installed 2-position fixed pan bracket, universal bar hanger included, ships uninstalled

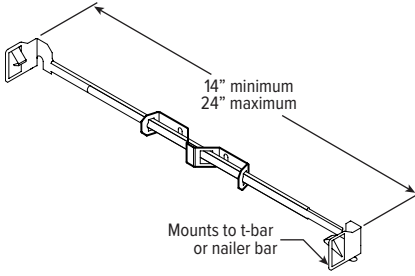

BA1 Adjustable butterfly pan bracket, bar hanger not included (N Mounting Type only)

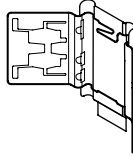

CA1 Adjustable caterpillar pan bracket, universal bar hanger included (N Mounting Type only)

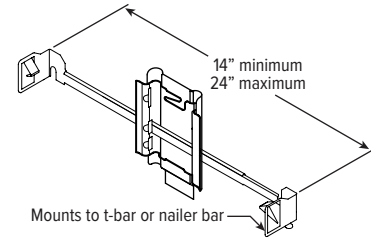

BA2 Adjustable butterfly pan bracket, heavy-duty universal bar hanger included (N Mounting Type only)

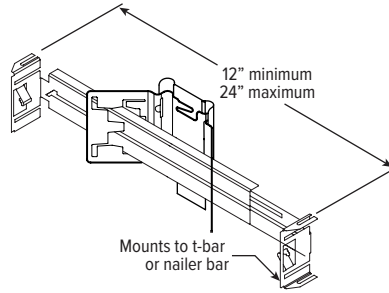

CA2 Adjustable caterpillar pan bracket, t-bar hanger included (N Mounting Type only)

