

CATALOG #: _____

TYPE: _____

PROJECT: _____

NEW CONSTRUCTION AND REMODEL

FEATURES

- Tunable white from 2700K to 5000K CCT, minimum 80 CRI
- Beam angles ranging from 25° narrow to 65° wide for tailored performance
- Square shape accentuates architectural styles
- Open reflector with 7 finishes to complement any interior style
- Die cast trim choices include flush, regressed or angled lens
- Spring clip retention system eliminates trim sag
- Contemporary design provides glare-free illumination for a soft ceiling appearance
- Fully room-side accessible

SPECIFICATIONS

- HOUSING** – Die-cast aluminum trim housing with forged aluminum heat sink. Galvanized steel splice compartment with driver mounting plate/enclosure. Swing-out mounting arms adjust for ceiling thickness from 1/2" - 1-7/16" (see options for additional ceiling thicknesses).
- OPEN REFLECTOR** – Low-iridescent anodized aluminum.
- LENSED TRIM** – Die-cast aluminum frame with micro-prismatic, tempered glass lens.
- ELECTRICAL** – High-performance Class 2 LED array. Modular quick-connect plug for easy field-connection of LED light assembly to driver. Reported L70>50,000 hours. Tunable White products use LEDs of multiple CCTs and may produce a perceptibly different shade of white from single-CCT products at the same CCT. All CCTs are within 3 MacAdam ellipses.
- MOUNTING** – Recessed. 20 ga. galvanized steel mounting pan for new construction or IC-rated enclosure. Remodel kit option includes receiver bracket hardware.
- LISTINGS** –
 - cCSAus conforms to UL STD 1598; Certified to CAN/CSA STD C22.2 No. 250.0 for damp locations. LED light assembly conforms to UL 2108 for remote installation.
 - Suitable for wet location under covered ceiling when specified with WET/CC option.
 - IC-rated for direct contact with insulation when specified with I Mounting Type.
 - City of Chicago Environmental Air approved when specified with CP option.
 - Complies with ASTM-E283 when specified with ATH option.
 - RoHS compliant.
- WARRANTY** – 5-year limited warranty, see <http://www.com/warranty>.

ORDERING EXAMPLE: 6DS - L20/8TW - OPTIONS - DIM - UNV - LW - OF - WH - TRIM OPTIONS - N - F1

HOUSING

SERIES	LUMENS ^[1]	COLOR	OPTIONS	CONTROL	VOLTAGE
6DS	L11	1,100lm	EM/7W	DALI Driver prewired for DALI applications DIM Dimming driver with (1) 0-10V signal to control dimming and (1) 0-10V signal to control CCT DMX Driver prewired for DMX applications	UNV 120-277V
	L20	2,000lm	EM/10W		
	L36	3,600lm	EM/10W/RTS		
			ATH CP F TC		

TRIM^[6]

TRIM TYPE	DISTRIBUTION ^[7]	FLANGE TYPE	REFLECTOR FINISH	TRIM OPTIONS
O Open reflector	W Wide	OF 1/2" standard flange	Open trim types	MWT Textured white trim flange ^[14]
L Flush lens	55° Open	SF 1/4" mud-in flange ^[12]	CS Clear semi-specular anodize	IP IP65 rated trim ^[15]
R Regressed lens	65° Flush		SG Satin-glow anodize	AD Diffuse acrylic lens ^[16]
A Angled lens ^[8]	65° Regressed		GD Gold anodize	PD Diffuse 1/8" polycarbonate lens ^[17]
	M Medium ^[9]		CG Champagne gold anodize	WET/CC Wet location, covered ceiling listed ^[18]
	50° Open		PW Pewter anodize	AM Anti-microbial ^[19]
	35° Flush		SPC Clear specular anodize	
	35° Regressed		RG Rose gold anodize	
	N Narrow ^[10]		Lens trim types	
	45° Open		CS Clear semi-specular powder coat	
	25° Flush		WH White texture powder coat	
	25° Regressed		BL Black texture powder coat	
	WW Wall wash ^[11]		MB Black texture spray with white flange ^[13]	

MOUNTING

MOUNTING TYPE^[20]

- N Open pan for new construction
- I IC-rated enclosure for new construction^[22]
- R Remodel kit^[23]

MOUNTING HARDWARE^[21]

- F1 Integral 2-position fixed pan bracket, universal bar hanger included^[24]
- BA1 Adjustable butterfly pan bracket, bar hanger not included^[25]
- CA1 Adjustable caterpillar pan bracket, universal bar hanger included^[26]

NOTES

- Lumen output based on L trim type, W distribution and WH finish, 4000K/80CRI. Actual lumens may vary +/-5%. See page 2 for FIXTURE PERFORMANCE DATA.
- N and R Mounting Types only.
- N and R Mounting Types only.
- Not available with WET/CC, ATH or IP options. N and R Mounting Types only. See page 5 for EM/10W/RTS DETAILS.
- I Mounting Type required.
- Trim ships separately.
- Beam angle based on CS or WH reflector finish.
- Available with WW Distribution only.
- Not available with lumen stop L36.
- Not available with lumen stop L36.
- O and A Trim Types only.
- For use with mud-in plaster construction only, supplied with mud flange installation kit. See page 4 for FLANGE TYPE DETAILS. Not available with ATH or IP options.
- R Trim Type only. Not available with MWT.
- Not available with WH Reflector Finish or L Trim Type.
- L and R Trim Types only.
- Not available with O trim type. W distribution only.
- Not available with O trim type. W distribution only.
- Not available with O Trim Type.
- WH and BL Reflector Finishes only.
- Mounting hardware required (N and I only), ordered separately, see MOUNTING HARDWARE ordering info. See page 4 for MOUNTING TYPE DETAILS.
- Additional mounting hardware options available. See page 5 for MOUNTING HARDWARE DETAILS.
- L20 lumen package max.
- Also used in new construction sheetrock ceilings.
- N and I Mounting Types only.
- N Mounting Type only.
- N Mounting Type only.



FIXTURE PERFORMANCE DATA

OPEN REFLECTOR TRIM TYPE

	DISTRIBUTION	DELIVERED LUMENS	WATTAGE	EFFICACY (lm/W)
L11	W	1097	14.6	75.4
	M	892	14.6	61.3
	N	880	14.6	60.5
L20	W	1863	24.0	77.5
	M	1513	24.0	63.0
	N	1455	24.0	60.5
L36	W	3474	44.9	77.5

FLUSH LENS TRIM TYPE

	DISTRIBUTION	DELIVERED LUMENS	WATTAGE	EFFICACY (lm/W)
L11	W	1168	14.6	80.2
	M	1196	14.6	82.2
	N	1165	14.6	80.0
L20	W	1990	24.0	82.9
	M	2027	24.0	84.5
	N	1929	24.0	80.4
L36	W	3698	44.9	82.4

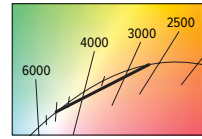

REGRESSED LENS TRIM TYPE

	DISTRIBUTION	DELIVERED LUMENS	WATTAGE	EFFICACY (lm/W)
L11	W	1122	14.6	77.1
	M	1165	14.6	80.0
	N	1159	14.6	79.6
L20	W	1906	24.0	79.2
	M	1969	24.0	82.0
	N	1916	24.0	79.7
L36	W	3553	44.9	79.2

MULTIPLIER TABLES

COLOR TEMPERATURE		
CCT	LUMENS	WATTS
2700K	0.83	1.03
3000K	1.00	1.00
3500K	0.99	0.99
4000K	1.00	1.00
5000K	0.98	1.03

OPEN REFLECTOR FINISH		
CATALOG NUMBER	REFLECTOR FINISH	CONVERSION FACTOR
CS	Clear semi-specular	1.00
SG	Satin-glow	0.92
GD	Gold	0.93
CG	Champagne Gold	0.96
PW	Pewter	0.86
SPC	Specular	1.02
RG	Rose Gold	0.88
WH	White, textured	0.89
BL	Black, textured	0.79

TRIM	
CATALOG NUMBER	CONVERSION FACTOR
AD	0.85
PD	0.85

- Photometrics tested in accordance with IESNA LM-79. Results shown are based on 25°C ambient temperature.
- Wattage shown is based on 120V input.
- Results based on 4000K, 80 CRI, actual lumens may vary +/-5%
- Use multiplier tables to calculate additional options.

PHOTOMETRY

6DS-L20/8TW-DIM-UNV-LW-OF-WH Total Luminaire Output: 1990 lumens; 24.0 Watts | Efficacy: 82.9 lm/W | 80.0 CRI; 4051K CCT

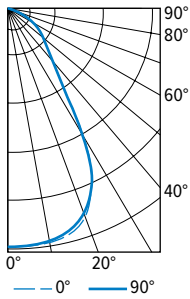

VERTICAL ANGLE	HORIZONTAL ANGLE			ZONAL LUMENS
	0°	45°	90°	
0	1344	1344	1344	
5	1348	1341	1343	128
15	1317	1300	1300	367
25	1097	1210	1102	514
35	502	810	504	404
45	305	352	298	257
55	193	197	191	174
65	99	99	96	99
75	38	37	36	41
85	3	2	4	7
90	0	0	0	

LUMEN SUMMARY	ZONE	LUMENS	% FIXTURE
	0 - 30	1009	51
	0 - 40	1413	71
	0 - 60	1844	93
	0 - 90	1990	100
	0 - 180	1990	100

6DS-L20/8TW-DIM-UNV-LM-OF-WH Total Luminaire Output: 2027 lumens; 24.0 Watts | Efficacy: 84.5 lm/W | 80.0 CRI; 4051K CCT

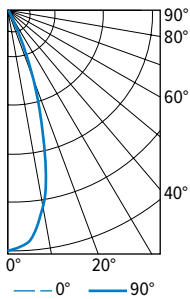

VERTICAL ANGLE	HORIZONTAL ANGLE			ZONAL LUMENS
	0°	45°	90°	
0	5546	5546	5546	
5	5280	5290	5325	479
15	3179	3144	3125	856
25	894	884	764	435
35	202	229	163	141
45	52	74	58	55
55	34	34	32	31
65	20	18	19	19
75	9	7	8	8
85	0	0	0	1
90	0	0	0	

LUMEN SUMMARY	ZONE	LUMENS	% FIXTURE
	0 - 30	1771	87
	0 - 40	1912	94
	0 - 60	1998	99
	0 - 90	2027	100
	0 - 180	2027	100



6DS tunable WHITE 6" Downlight – Square

6DS-L20/8TW-DIM-UNV-LN-OF-WH Total Luminaire Output: 1929 lumens; 24.0 Watts | Efficacy: 80.4 lm/W | 80.0 CRI; 4051K CCT

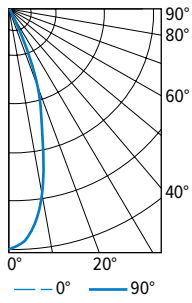

VERTICAL ANGLE	HORIZONTAL ANGLE			ZONAL LUMENS
	0°	45°	90°	
0	7637	7637	7637	
5	6816	6917	6812	596
15	2933	2876	2735	808
25	646	652	545	324
35	153	156	120	100
45	56	64	53	47
55	32	34	31	29
65	19	19	17	17
75	7	7	7	8
85	1	0	0	1
90	0	0	0	

LUMEN SUMMARY	ZONE	LUMENS	% FIXTURE
	0 - 30	1728	90
	0 - 40	1827	95
	0 - 60	1903	99
	0 - 90	1929	100
	0 - 180	1929	100

6DS-L20/8TW-DIM-UNV-OWW-OF-CS Total Luminaire Output: 1785 lumens; 24.0 Watts | Efficacy: 74.4 lm/W | 80.0 CRI; 4051K CCT

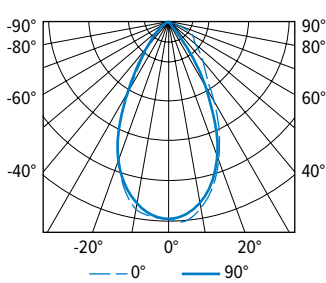

VERTICAL ANGLE	HORIZONTAL ANGLE					ZONAL LUMENS
	0°	45°	90°	135°	180°	
0	1866	1866	1866	1866	1866	
5	1889	1869	1833	1828	1846	174
15	1632	1619	1589	1623	1629	449
25	1152	1167	1089	1163	1033	513
35	657	631	424	568	429	344
45	455	265	138	184	174	177
55	311	73	17	28	31	76
65	251	13	0	0	2	38
75	99	1	0	0	0	14
85	0	0	0	0	0	1
90	0	0	0	0	0	

LUMEN SUMMARY	ZONE	LUMENS	% FIXTURE
	0 - 30	1136	64
	0 - 40	1480	83
	0 - 60	1732	97
	0 - 90	1785	100
	0 - 180	1785	100

6DS-L20/8TW-DIM-UNV-OM-OF-CS Total Luminaire Output: 1513 lumens; 24.0 Watts | Efficacy: 63.0 lm/W | 80.0 CRI; 4051K CCT

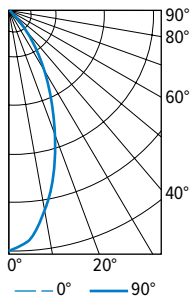

VERTICAL ANGLE	HORIZONTAL ANGLE			ZONAL LUMENS
	0°	45°	90°	
0	2325	2325	2325	
5	2222	2220	2229	204
15	1632	1621	1635	454
25	970	956	966	443
35	419	492	410	283
45	88	203	88	113
55	6	18	6	16
65	0	0	0	1
75	0	0	0	0
85	0	0	0	0
90	0	0	0	

LUMEN SUMMARY	ZONE	LUMENS	% FIXTURE
	0 - 30	1101	73
	0 - 40	1384	92
	0 - 60	1513	100
	0 - 90	1513	100
	0 - 180	1513	100

6DS-L20/8TW-DIM-UNV-RM-OF-WH Total Luminaire Output: 1969 lumens; 24.0 Watts | Efficacy: 82.0 lm/W | 80.0 CRI; 4051K CCT

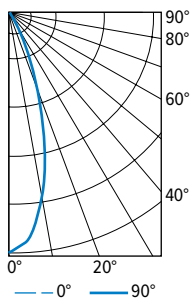

VERTICAL ANGLE	HORIZONTAL ANGLE			ZONAL LUMENS
	0°	45°	90°	
0	5029	5029	5029	
5	4767	4747	4786	430
15	2914	2877	2865	788
25	975	925	861	457
35	266	285	218	176
45	76	89	61	65
55	33	35	31	31
65	16	13	13	16
75	4	5	5	6
85	0	0	0	1
90	0	0	0	

LUMEN SUMMARY	ZONE	LUMENS	% FIXTURE
	0 - 30	1675	85
	0 - 40	1852	94
	0 - 60	1948	99
	0 - 90	1969	100
	0 - 180	1969	100



6DS tunable WHITE 6" Downlight – Square

TRIM TYPE DETAILS

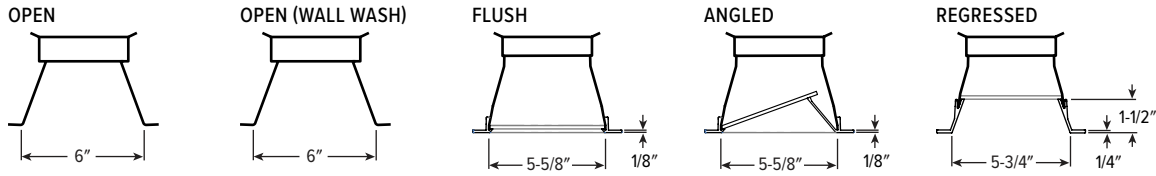

FLANGE TYPE DETAILS

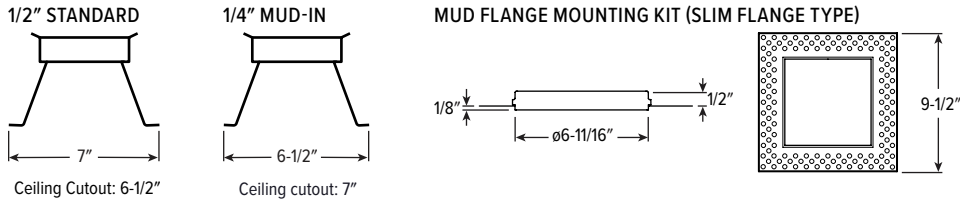

REFLECTOR FINISH DETAILS

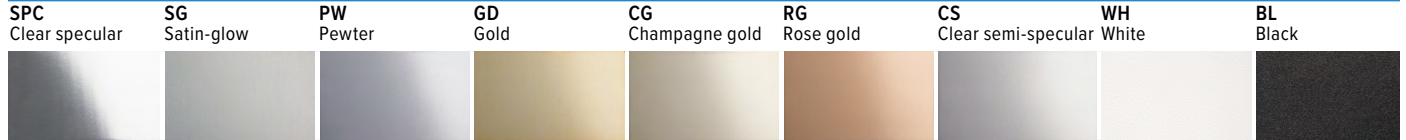

MOUNTING TYPE DETAILS

NEW CONSTRUCTION

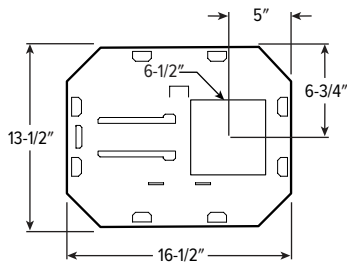

IC-RATED

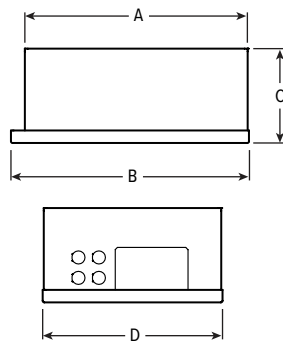

LUMENS	LENGTH			
	A	B	C	D
L11 - L20	15-3/16"	16"	6-3/8"	12-1/8"

REMODEL

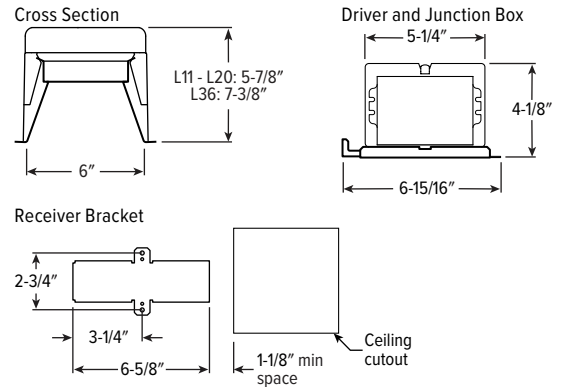

6DS tunable WHITE 6" Downlight – Square

EM/10W/RTS DETAILS

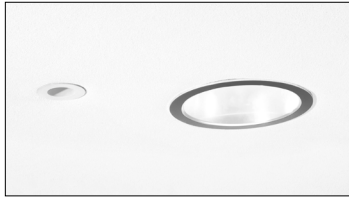

Shown Installed

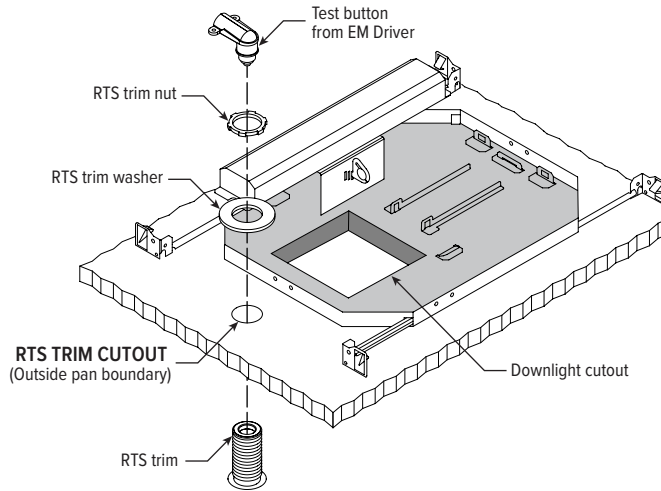

MOUNTING HARDWARE DETAILS

F1 Integral 2-position fixed pan bracket, universal bar hanger included

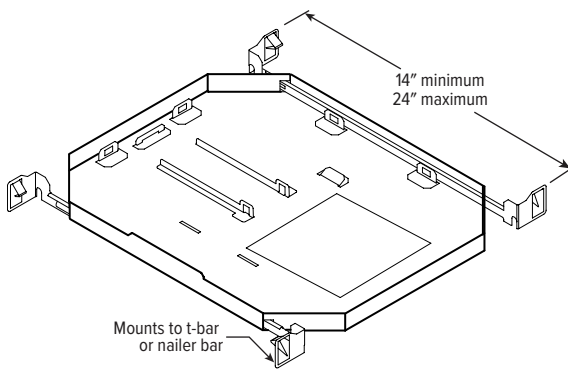

BA1 Adjustable butterfly pan bracket, bar hanger not included (N Mounting Type only)

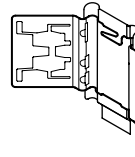

CA1 Adjustable caterpillar pan bracket, universal bar hanger included (N Mounting Type only)

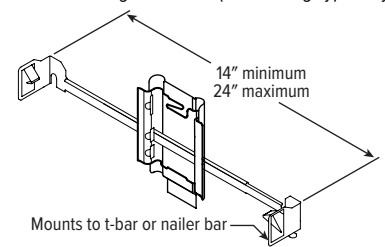

BA2 Adjustable butterfly pan bracket, heavy-duty universal bar hanger included (N Mounting Type only)

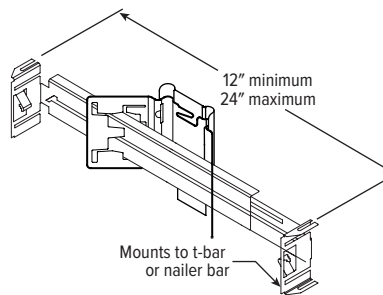

CA2 Adjustable caterpillar pan bracket, t-bar hanger included (N Mounting Type only)

