

VOLTAIRE MINI ARCHITECTURAL WALL PACK

VWM

LED

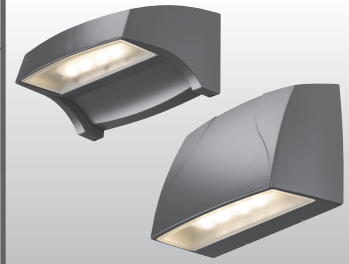

FEATURES

GENERAL

- ▶ Engineered with the highest quality materials to ensure reliability, performance, and quality.
- ▶ Provides security and accent lighting for walkways, entries, perimeters, and facades.
- ▶ Intended for use in both uplight and downlight applications.
- ▶ Aesthetically designed horizontal and vertical housings blend seamlessly with a variety of architectural styles.
- ▶ Purposefully modeled to allow runoff of dirt and water for an always-clean appearance.
- ▶ Optional energy-saving photocell available.
- ▶ Rated >50,000 hours at 70% lumen maintenance (L70).
- ▶ ANSI 3000K, 4000K, or 5000K CCT.
- ▶ Minimum 70 CRI.
- ▶ Available in six standard finish options.
- ▶ This fixture is proudly made in the USA.

THERMAL

- ▶ Integral die-cast aluminum heatsink provides optimal passive thermal management.
- ▶ Concealed heatsink design preserves architectural appearance.
- ▶ Rated ambient operating temperature -30°C to 50°C (L10, L17), -30°C to 45°C (L20).

OPTICAL

- ▶ Full cutoff, dark-sky compliant optics (downlight applications only) place light where it's needed with minimal glare.

ELECTRICAL

- ▶ 0-10V dimming standard.
- ▶ 10kA/10kV surge protection optional.



¹ For custom colors other than RAL, manufacturers' code plus two swatches (minimum 1" square) required.

CATALOG #:					TYPE:					
PROJECT:				NOTES:						
EXAMPLE VWM H - L20/740 - T3 - DBZ - SDGL - OPTIONS - DIM - UNV										
SERIES	TYPE	LUMEN PACKAGE	CRI & CCT	DISTRIBUTION	FINISH	SHIELDING	OPTIONS/ACCESSORIES	DRIVER	VOLTAGE	

CROSS SECTIONS

VWMH (Weight: 6.5 Lbs)

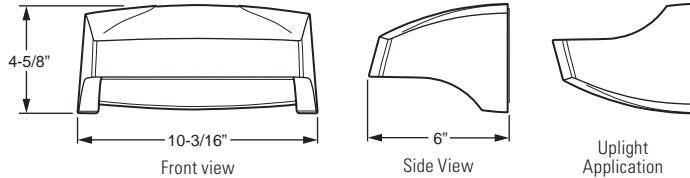

VWMV (Weight: 6.5 Lbs)

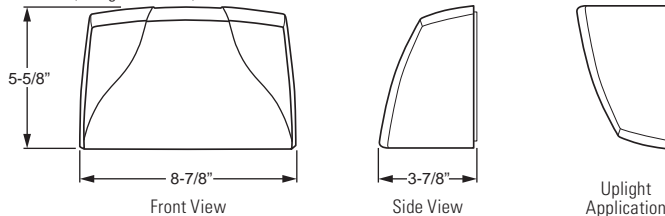

ORDERING INFORMATION

SERIES
VWM Voltaire Mini Architectural Wall Pack

TYPE
H Horizontal
V Vertical

LED PACKAGE

See back for fixture performance data.

Example: L17/740			
LUMEN PACKAGE	NOMINAL LUMENS	MINIMUM CRI & CCT	AVERAGE SYSTEM WATTAGE
L10	1,000	830 = 80 CRI, 3000K	13
		840 = 80 CRI, 4000K	
		750 = 70 CRI, 5000K	
L17	1,700	730 = 70 CRI, 3000K	16
		740 = 70 CRI, 4000K	
		750 = 70 CRI, 5000K	
L20	2000	730 = 70 CRI, 3000K 740 = 70 CRI, 4000K 750 = 70 CRI, 5000K	25

DISTRIBUTION
TL Lambertian distribution (L10 & L17 only)
T3 Type III (L20 only)

FINISH OPTIONS
 For custom color, visit the VWM at hew.com.¹
BLK Black (RAL #9004)
DBZ Dark bronze
DBR Medium bronze
GRAY Standard gray
SLV Satin aluminum (RAL #9006)
WHT White (RAL #9003)

SHIELDING
SDGL Solite® diffused textured tempered glass lens
CGL Clear tempered glass lens

OPTIONS
 See back for option details.
PC Factory-installed button-style photocell (120V, 208V, or 277V only; must specify voltage)
SP10 10kA/10kV surge protection

DRIVER
DIM Dimming driver prewired for 0-10V controls

VOLTAGE
120 120V
208 208V
277 277V
UNV 120-277V

LED

DISTRIBUTION DETAILS

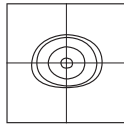

VWMH TL

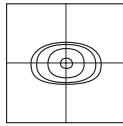

VWMV TL

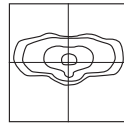

VWMH/V T3
Clear Glass (CGL)

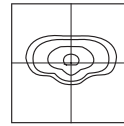

VWMH/V T3
Solite Glass (SDGL)

SPECIFICATIONS

Housing – Die-cast aluminum enclosure.
Thermal Management – Integral die-cast aluminum heatsink and LED source provide passive thermal management. Rated ambient operating temperature -30°C to 50°C (L10, L17), -30°C to 45°C (L20).

Optical System – General output provides full cutoff.

LED Source – ANSI 3000K, 4000K, or 5000K CCT; 70 or 80 CRI LEDs. L20: circuit board design. L10 & L17: Chip on board.

LED Driver – 0-10V dimming.

Electrical – 120-277 VAC input range; 50-60Hz; power factor >.90; THD <20% at full load. FCC Class A compliant. Quick-disconnect wiring provided.

Finish – Super durable polyester powder coat bonded to phosphate-free, multi-stage pretreated metal, meets and exceeds AAMA 2604 specifications for outdoor durability. Available in six standard colors. Custom colors available.

Mounting – Surface mounts directly over a 4" maximum outlet box. Must be anchored to adequate structure that can safely support fixture weight (6.5 Lbs).

Listings –

- cCSAus certified as luminaire suitable for wet locations.
- DesignLights Consortium qualified product. Not all versions of this product may be DLC qualified, see the DLC Qualified Products List at www.designlights.org/QPL.
- Calculated L70 >50,000 hours per IES TM-21.
- Tested to IES LM-79-08 standards.
- Lighting Facts listed.
- IDA Dark-Sky approved (downlight applications only).
- RoHS compliant.
- IP65 rated.
- Title 24 compliant with PC option.
- BUG classified per IES TM-15-11.

Warranty – 5-year limited warranty, see hew.com/warranty.

FIXTURE PERFORMANCE DATA

Series	Distribution	Lumen Package	Average System Wattage ¹	CCT	Clear Glass (CGL)		Solite Glass (SDGL)		BUG Ratings	
					Delivered Lumens ^{2,3}	Efficacy (lm/W) ^{2,3}	Delivered Lumens ^{2,3}	Efficacy (lm/W) ^{2,3}		
VWMH	TL	L10	13	3000	1188	91.3	1104	85.0	B1-U0-G0	
				4000	1250	96.2	1163	89.4		
				5000	1349	103.8	1255	96.5		
	T3	L20	25	3000	1644	102.8	1529	95.6		B1-U0-G1
				4000	1731	108.2	1610	100.6		
				5000	1840	115.0	1711	107.0		
VWMV	TL	L10	13	3000	1006	77.4	936	72.0	B1-U0-G0	
				4000	1059	81.5	985	75.8		
				5000	1201	92.4	1117	85.9		
		L17	16	3000	1520	95.0	1414	88.4		
				4000	1600	100.0	1488	93.0		
				5000	1704	106.5	1585	99.0		
	T3	L20	25	3000	2139	85.6	2022	80.9	B1-U0-G1	
				4000	2290	91.6	2136	85.4		
				5000	2301	92.0	2146	85.8		

¹ Wattage shown is average for 120V through 277V input.

² Efficacy/lumen output shown is average based on voltage input of 120V through 277V.

³ Photometrics tested in accordance with IESNA LM-79. Results shown are based on 25°C ambient temperature.

LUMEN MAINTENANCE

Lumen Package	Ambient Temp.	Reported L70 Hours (TM-21)
L20	25°C	>60,000
	35°C	>60,000
	45°C	>60,000
L10/L17	25°C	>55,000
	35°C	>55,000
	45°C	>55,000

- Predicted lumen maintenance calculated from LED manufacturer IES LM-80 data and in-situ temperature measurement.
- Reported L70 hours in accordance with IES TM-21

OPTIONS

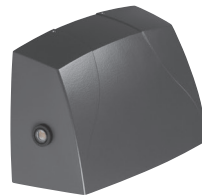

PC

Factory-installed button-style photocell (120V, 208V, or 277V only; must specify voltage)

MOUNTING DETAILS

BOLT PATTERN DETAIL

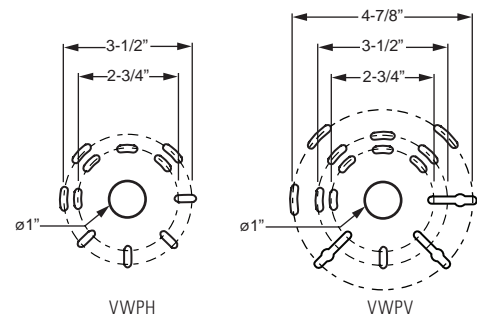

VWPV

VWPV