

# 6AR<sup>LED</sup> 6" Adjustable Downlight – Round

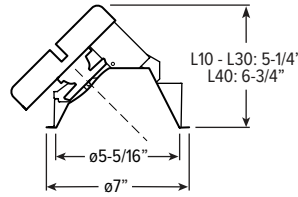

CATALOG #: \_\_\_\_\_

TYPE: \_\_\_\_\_

PROJECT: \_\_\_\_\_

## NEW CONSTRUCTION AND REMODEL

### FEATURES

- Adjustable aim with 0° - 45° tilt and 360° rotation
- Beam angles ranging from 25° narrow to 55° wide for tailored performance
- Spring clip retention system eliminates trim sag
- Etched degree markers and directional indicator make it simple to fine-tune the illumination angle
- Choice of open reflector or die-cast lensed trims to complement interior style
- Contemporary design provides glare-free illumination for a soft ceiling appearance
- Fully room-side accessible

### SPECIFICATIONS

- HOUSING** – Die-cast aluminum spun and stamped articulating mechanism with forged aluminum heat sink. Galvanized steel splice compartment with driver mounting plate/enclosure. Mounting clips allow for ceiling thickness from 1/2" - 7/8" (consult factory for additional ceiling thicknesses).
- OPEN REFLECTOR** – Low-iridescent anodized aluminum. Clear semi-specular finish standard.
- LENSED TRIM** – Die-cast aluminum frame with micro-prismatic, tempered glass lens.
- ELECTRICAL** – High-performance Class 2 C.O.B. LED array. Modular quick-connect plug for easy field-connection of LED light assembly to driver. Reported L70>55,000 hours. Reported L90>55,000 hours. Estimated L70 = 200,000 hours.
- MOUNTING** – Recessed. 20 ga. galvanized steel mounting pan for new construction or IC-rated enclosure. Remodel kit option includes receiver bracket hardware. N and R mounting types for use in non-fire rated installations only. Minimum 24" O.C. marked spacing required for L30 and L40 lumen packages.
- LISTINGS** –
  - cCSAus conforms to UL STD 1598; Certified to CAN/CSA STD C22.2 No. 250.0 for damp locations. LED light assembly conforms to UL 2108 for remote installation.
  - IC-rated for direct contact with insulation when specified with I Mounting Type.
  - City of Chicago Environmental Air approved when specified with CP option.
  - Complies with ASTM-E283 when specified with ATH option.
  - RoHS compliant.
- WARRANTY** – 5-year limited warranty, see [hew.com/warranty](http://hew.com/warranty).

ORDERING EXAMPLE:<sup>[1]</sup> 6AR - L20/835 - OPTIONS - DIM - UNV - OW - OF - CS - TRIM OPTIONS - N - F1  
 HOUSING TRIM MOUNT.

### HOUSING

SERIES	LUMENS <sup>[2]</sup>	CRI	CCT	OPTIONS	DRIVER <sup>[3]</sup>	VOLTAGE
6AR	L10 1,000lm	80	27	2700K	EM/10W 10-watt emergency battery <sup>[4]</sup>	DIM Dimming driver, 0-10V
	L15 1,500lm	90	30	3000K	ATH Airtight construction <sup>[5]</sup>	
	L20 2,000lm		35	3500K	CP Chicago plenum (CCEA) <sup>[6]</sup>	DIM1 1% Dimming driver, 0-10V
	L30 3,000lm		40	4000K	F Fuse kit	
	L40 4,000lm			SDT Stepdown transformer <sup>[7]</sup>		

### TRIM

TRIM TYPE	DISTRIBUTION <sup>[9]</sup>	FLANGE TYPE	REFLECTOR FINISH	TRIM OPTIONS
<b>O</b> Open reflector	<b>W</b> Wide	<b>OF</b> 1/2" standard flange	<b>Open trim types</b>	<b>MWT</b> Textured white trim flange <sup>[12]</sup>
<b>L</b> Flush lens	55° Open	<b>SF</b> 1/4" mud-in flange <sup>[10]</sup>	<b>CS</b> Clear semi-specular anodize <sup>[11]</sup>	<b>AD</b> Diffuse acrylic lens <sup>[13]</sup>
<b>A</b> Angled lens	55° Flush 50° Angled		<b>WH</b> White texture powder coat	<b>PD</b> Diffuse 1/8" polycarbonate lens <sup>[14]</sup>
	<b>M</b> Medium		<b>BL</b> Black texture powder coat	
	35° Open	<b>Lens trim types</b>		
	35° Flush		<b>CS</b> Clear semi-specular powder coat	
	35° Angled		<b>WH</b> White texture powder coat	
	<b>N</b> Narrow		<b>BL</b> Black texture powder coat	
	25° Open			
	25° Flush			
	30° Angled			

### MOUNTING

#### MOUNTING TYPE<sup>[15]</sup>

- N** Open pan for new construction
- I** IC-rated enclosure for new construction<sup>[17]</sup>
- R** Remodel kit<sup>[18]</sup>

#### MOUNTING HARDWARE<sup>[16]</sup>

- F1** 2-Position fixed pan bracket, universal bar hanger included
- F2** 2-Position fixed pan bracket, t-bar bar hanger included
- BA1** Adjustable butterfly pan bracket, bar hanger not included<sup>[19]</sup>
- BA2** Adjustable butterfly pan bracket, heavy-duty universal bar hanger included<sup>[20]</sup>
- CA1** Adjustable caterpillar pan bracket, universal bar hanger included
- CA2** Adjustable caterpillar pan bracket, t-bar hanger included

### NOTES

- Housing, trim, and mounting ship separately.
- Lumen output based on O trim type, W distribution and CS finish, 3500K/80CRI. Actual lumens may vary +/-5%, see page 2 for FIXTURE PERFORMANCE DATA.
- See page 3 for ADDITIONAL DRIVER OPTIONS.
- N Mounting Type only.
- I Mounting Type required.
- I Mounting Type required.
- May be required for 347V, see product builder at [hew.com](http://hew.com).
- Not available with EM batteries.
- Beam angle based on CS or WH reflector finish.
- For use with mud-in plaster construction only, supplied with mud flange installation kit, see page 4 for FLANGE TYPE DETAILS, not available with CP or ATH option.

- O Trim Type only.
- O Trim Type and OF Flange Type only. Not available with WH Reflector Finish.
- L and A Trim Types only. Wide distribution only.
- L and A Trim Types only. Wide distribution only.
- Mounting hardware required (N and I only), ordered separately, see MOUNTING HARDWARE ordering info. See page 4 for MOUNTING TYPE DETAILS.
- Specify for N and I Mounting Types only, see page 5 for MOUNTING HARDWARE DETAILS.
- L30 lumen package max.
- Also used in new construction sheetrock ceilings.
- N Mounting Type only.
- N Mounting Type only.



# 6AR LED 6" Adjustable Downlight – Round

## FIXTURE PERFORMANCE DATA

### OPEN REFLECTOR TRIM TYPE

LED PACKAGE	DISTRIBUTION	DELIVERED LUMENS	WATTAGE	EFFICACY (lm/W)
L10	W	1020	10.5	97.1
	M	1023	10.5	97.4
	N	1022	10.5	97.4
L15	W	1537	15.1	101.8
	M	1542	15.1	102.1
	N	1541	15.1	102.1
L20	W	2039	21.0	97.1
	M	2045	21.0	97.4
	N	2044	21.0	97.3
L30	W	2917	31.3	93.2
	M	2915	31.3	93.1
	N	2790	31.3	89.2
L40	W	3889	42.0	92.6
	M	3886	42.0	92.5
	N	3720	42.0	88.6

### FLUSH LENS TRIM TYPE

LED PACKAGE	DISTRIBUTION	DELIVERED LUMENS	WATTAGE	EFFICACY (lm/W)
L10	W	896	10.5	85.3
	M	956	10.5	91.1
	N	951	10.5	90.6
L15	W	1350	15.1	89.4
	M	1442	15.1	95.5
	N	1433	15.1	94.9
L20	W	1791	21.0	85.3
	M	1912	21.0	91.0
	N	1901	21.0	90.5
L30	W	2559	31.3	81.8
	M	2717	31.3	86.8
	N	2609	31.3	83.4
L40	W	3411	42.0	81.2
	M	3622	42.0	86.2
	N	3478	42.0	82.8

### ANGLED LENS TRIM TYPE

LED PACKAGE	DISTRIBUTION	DELIVERED LUMENS	WATTAGE	EFFICACY (lm/W)
L10	W	744	10.5	70.9
	M	889	10.5	84.7
	N	907	10.5	86.4
L15	W	1122	15.1	74.3
	M	1340	15.1	88.7
	N	1368	15.1	90.6
L20	W	1488	21.0	70.9
	M	1777	21.0	84.6
	N	1814	21.0	86.4
L30	W	2144	31.3	68.5
	M	2507	31.3	80.1
	N	2441	31.3	78.0
L40	W	2858	42.0	68.0
	M	3342	42.0	79.6
	N	3254	42.0	77.5

### MULTIPLIER TABLES

	COLOR TEMPERATURE	
	CCT	CONVERSION FACTOR
80 CRI	2700K	0.95
	3000K	0.96
	3500K	1.00
	4000K	1.01
90 CRI	2700K	0.74
	3000K	0.85
	3500K	0.90
	4000K	0.91

OPEN REFLECTOR FINISH		
CATALOG NUMBER	REFLECTOR FINISH	CONVERSION FACTOR
CS	Clear semi-specular	1.00
WH	White, textured	0.89
BL	Black, textured	0.79

- Photometrics tested in accordance with IESNA LM-79. Results shown are based on 25°C ambient temperature.
- Wattage shown is based on 120V input.
- Results based on 3500K, 80 CRI, 0° tilt, actual lumens may vary +/-5%
- Use multiplier table to calculate additional options.

## PHOTOMETRY

6AR-L20/835-DIM-UNV-OW-OF-CS (25° tilt) Report #: 20390; 05/16/18 | Total Luminaire Output: 1958 lumens; 21.2 Watts | Efficacy: 92.5 lm/W | 82.3 CRI; 3571K CCT

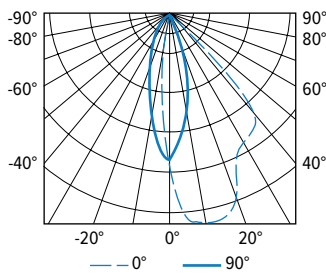

CANDLEPOWER DISTRIBUTION	VERTICAL ANGLE	HORIZONTAL ANGLE					ZONAL LUMENS
		0°	45°	90°	135°	180°	
	0	2605	2605	2605	2605	2605	
	5	3639	3208	2308	1607	1297	227
	15	3810	2844	1321	442	310	469
	25	2919	2543	541	122	92	548
	35	2592	1908	109	26	20	499
	45	1695	212	11	6	6	212
	55	20	2	0	0	2	3
	65	0	0	0	0	0	0
	75	0	0	0	0	0	0
	85	0	0	0	0	0	0
	90	0	0	0	0	0	0

LUMEN SUMMARY	ZONE	LUMENS	% FIXTURE
	0 - 30	1244	64
	0 - 40	1743	89
	0 - 60	1958	100
	0 - 90	1958	100
	0 - 180	1958	100

6AR-L20/835-DIM-UNV-OM-OF-CS (25° tilt) Report #: 20393; 05/16/18 | Total Luminaire Output: 2061 lumens; 21.2 Watts | Efficacy: 97.3 lm/W | 82.3 CRI; 3573K CCT

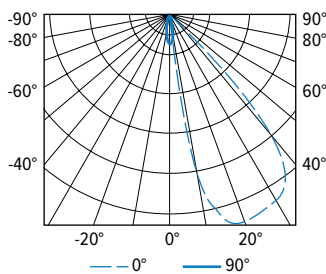

CANDLEPOWER DISTRIBUTION	VERTICAL ANGLE	HORIZONTAL ANGLE					ZONAL LUMENS
		0°	45°	90°	135°	180°	
	0	876	876	876	876	876	
	5	2125	1458	741	436	355	94
	15	6181	2392	370	157	133	452
	25	6270	1772	155	66	53	729
	35	5751	647	59	13	8	663
	45	1223	145	5	0	0	119
	55	36	0	0	0	0	4
	65	0	0	0	0	0	0
	75	0	0	0	0	0	0
	85	0	0	0	0	0	0
	90	0	0	0	0	0	0

LUMEN SUMMARY	ZONE	LUMENS	% FIXTURE
	0 - 30	1275	62
	0 - 40	1938	94
	0 - 60	2061	100
	0 - 90	2061	100
	0 - 180	2061	100

# 6AR LED 6" Adjustable Downlight – Round

6AR-L20/835-DIM-UNV-ON-OF-CS (25° tilt) Report #: 20396; 05/16/18 | Total Luminaire Output: 2055 lumens; 21.2 Watts | Efficacy: 97.0 lm/W | 82.2 CRI; 3566K CCT

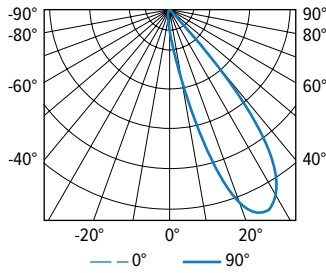

CANDLEPOWER DISTRIBUTION	VERTICAL ANGLE	HORIZONTAL ANGLE					ZONAL LUMENS
		0°	45°	90°	135°	180°	
	0	544	544	544	544	544	
	5	1499	1037	474	257	214	62
	15	7740	1732	220	112	102	409
	25	11615	1429	94	59	55	902
	35	8449	498	49	38	43	550
	45	1454	92	16	3	0	128
	55	75	3	0	0	0	5
	65	0	0	0	0	0	0
	75	0	0	0	0	0	0
	85	0	0	0	0	0	0
	90	0	0	0	0	0	0

LUMEN SUMMARY	ZONE	LUMENS	% FIXTURE
	0 - 30	1372	67
	0 - 40	1922	94
	0 - 60	2055	100
	0 - 90	2055	100
	0 - 180	2055	100

6AR-L20/835-DIM-UNV-LM-OF-WH (25° tilt) Report #: 20402; 05/16/18 | Total Luminaire Output: 1882 lumens; 21.2 Watts | Efficacy: 88.9 lm/W | 82.2 CRI; 3569K CCT

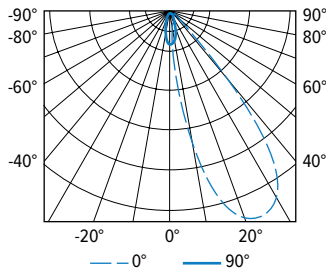

CANDLEPOWER DISTRIBUTION	VERTICAL ANGLE	HORIZONTAL ANGLE					ZONAL LUMENS
		0°	45°	90°	135°	180°	
	0	841	841	841	841	841	
	5	2194	1584	784	463	353	95
	15	4980	2460	437	174	143	402
	25	5745	1942	204	98	90	626
	35	4119	846	97	66	71	489
	45	1191	222	49	56	66	170
	55	244	58	32	45	56	62
	65	53	22	19	29	38	27
	75	18	9	7	12	19	11
	85	0	0	0	0	0	0
	90	0	0	0	0	0	0

LUMEN SUMMARY	ZONE	LUMENS	% FIXTURE
	0 - 30	1123	60
	0 - 40	1612	86
	0 - 60	1843	98
	0 - 90	1882	100
	0 - 180	1882	100

6AR-L20/835-DIM-UNV-AM-OF-WH (25° tilt) Report #: 20411; 05/16/18 | Total Luminaire Output: 1806 lumens; 21.2 Watts | Efficacy: 85.4 lm/W | 82.2 CRI; 3576K CCT

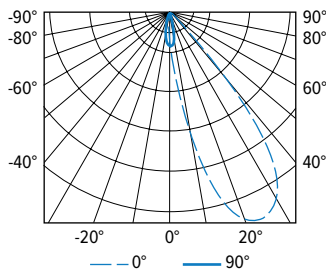

CANDLEPOWER DISTRIBUTION	VERTICAL ANGLE	HORIZONTAL ANGLE					ZONAL LUMENS
		0°	45°	90°	135°	180°	
	0	821	821	821	821	821	
	5	1836	1385	741	441	355	87
	15	4735	2261	406	153	116	378
	25	5677	1817	175	69	56	613
	35	4495	765	74	36	36	507
	45	1358	198	33	25	30	182
	55	134	28	17	18	21	29
	65	14	7	7	10	12	9
	75	5	1	0	1	3	1
	85	0	0	0	0	0	0
	90	0	0	0	0	0	0

LUMEN SUMMARY	ZONE	LUMENS	% FIXTURE
	0 - 30	1077	60
	0 - 40	1585	88
	0 - 60	1796	99
	0 - 90	1806	100
	0 - 180	1806	100

## ADDITIONAL DRIVER OPTIONS

Lumen restrictions apply: L30 max for DMX driver, L40 max for Lutron drivers. 347V may require stepdown transformer, see product builder at [hew.com](http://hew.com).

CATALOG NUMBER	DESCRIPTION
DIM	Dimming driver prewired for 0-10V low voltage applications
DIM1	1% dimming driver prewired for 0-10V low voltage applications
DMX	0.1% dimming driver for DMX controls
LTE LINE	Lutron Hi-Lume® A-Series 1% dimming driver for forward phase line voltage controls (120V only)
LDE1	Lutron EcoSystem® H-Series 1% dimming driver for EcoSystem® controls
LDE5	Lutron EcoSystem® 5-Series 5% dimming driver for EcoSystem® controls
ELDO SOLOB	EldoLED Solodrive, 0.1% dimming driver for 0-10V controls
ELDO SOLOB DALI	EldoLED Solodrive, 0.1% dimming driver for DALI controls
ELDO ECO1	EldoLED Ecodrive, 1% dimming driver for 0-10V controls
ELDO ECO1 DALI	EldoLED Ecodrive, 1% dimming driver for DALI controls

# 6AR LED 6" Adjustable Downlight – Round

## TRIM TYPE DETAILS

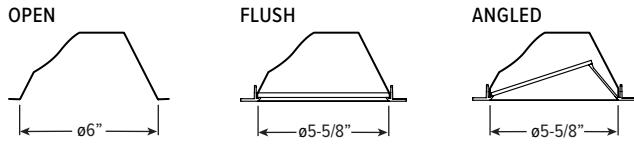

## FLANGE TYPE DETAILS

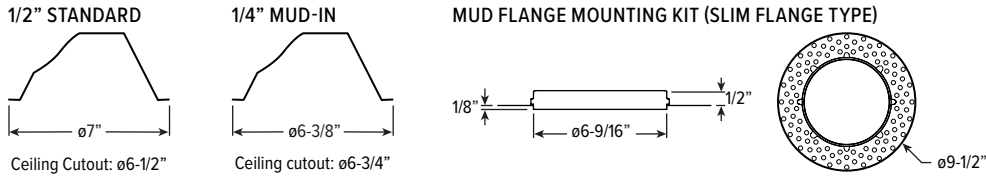

## REFLECTOR FINISH DETAILS

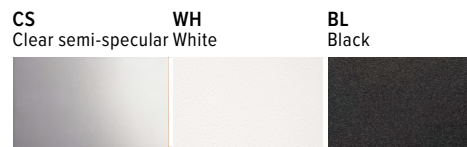

## MOUNTING TYPE DETAILS

**NEW CONSTRUCTION**  $\phi 6-1/2''$   $6-3/8''$   $6-1/4''$   $14''$   $17-1/2''$   
**IC-RATED** A B C D  
**REMODEL**  $5-1/4''$   $4-1/8''$   $6-15/16''$  Driver and Junction Box  
 $2-3/4''$   $3-1/4''$   $6-5/8''$  Receiver bracket  
 $3-1/4''$  min space Ceiling cutout

LUMENS	LENGTH			
	A	B	C	D
L10 - L20	15-3/16"	16"	6-3/8"	12-1/8"
L30	16-5/8"	17-1/2"	7-7/8"	14"

# 6AR LED 6" Adjustable Downlight – Round

## MOUNTING HARDWARE DETAILS

**F1** 2-Position fixed pan bracket, universal bar hanger included

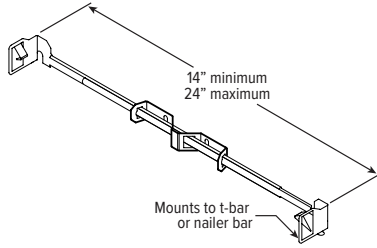

**BA1** Adjustable butterfly pan bracket, bar hanger not included

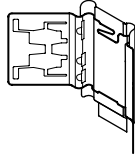

**CA1** Adjustable caterpillar pan bracket, universal bar hanger included

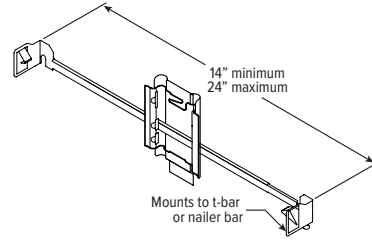

**F2** 2-Position fixed pan bracket, t-bar bar hanger included

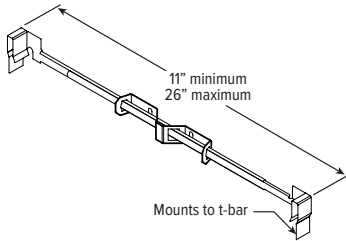

**BA2** Adjustable butterfly pan bracket, heavy-duty universal bar hanger included

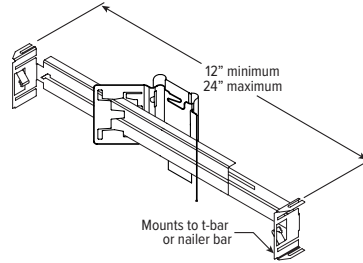

**CA2** Adjustable caterpillar pan bracket, t-bar hanger included

