

M6PR LED 6" MRI Shallow Plenum Downlight – Round

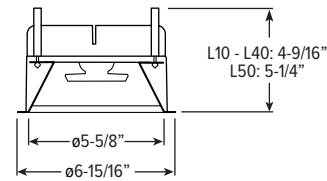

Pan Size: 12-1/6" x 16-1/4"

CATALOG #: _____

TYPE: _____

PROJECT: _____

FEATURES

TrimLock™

- Williams TrimLock reflector retention system eliminates trim sag
- Designed with non-ferrous materials for MRI imaging suites
- IP65-rated die-cast trim includes easy-to-clean flush lens
- Slim 5" depth for minimal plenum space applications
- Beam angles ranging from 25° narrow to 85° wide for tailored performance
- Contemporary design provides glare-free illumination for a soft ceiling appearance
- Industry-leading efficacies as high as 106 lm/W
- Fully room-side accessible

SPECIFICATIONS

- HOUSING** – Spun housing with forged aluminum heat sink. Aluminum splice compartment. Trim housing adjusts for ceiling thickness from 1/2" - 1-1/2".
- TRIMLOCK** – Innovative TrimLock reflector retention system ensures the trim remains flush with the ceiling plane.
- LENSED TRIM** – Die-cast aluminum frame with micro-prismatic, tempered glass lens.
- ELECTRICAL** – High-performance Class 2 C.O.B. LED array. Modular quick-connect plug for easy field-connection of LED light assembly to splice compartment. Reported L70>55,000 hours. Reported L90>55,000 hours. Estimated L70 = 200,000 hours. Remote mounted driver box must be located outside MRI room.
- MOUNTING** – Recessed. Aluminum mounting pan for new construction or IC-rated enclosure. Minimum 24" O.C. marked spacing required for L50 lumen package. Remote mounted driver enclosure required, ordered separately, must be located outside MRI room.
- LISTINGS** –
 - cCSAus conforms to UL STD 1598; Certified to CAN/CSA STD C22.2 No. 250.0 for damp locations. LED light assembly conforms to UL 2108 for remote installation.
 - Suitable for wet location under covered ceiling when specified with WET/CC option.
 - IC-rated for direct contact with insulation when specified with I Mounting Type.
 - City of Chicago Environmental Air approved when specified with CP option.
 - Complies with ASTM-E283 when specified with ATH option.
 - RoHS compliant.
- WARRANTY** – 5-year limited warranty, see hew.com/warranty.

ORDERING EXAMPLE:⁽¹⁾ **M6PR - TL - L20/835 - OPTIONS - LW - OF - WH - TRIM OPTIONS - N - F1M**

HOUSING

SERIES	LUMENS ⁽²⁾	CRI	CCT	OPTIONS
M6PR - TL	L10 1,000lm	8 80	27 2700K	ATH Airtight construction ⁽⁴⁾
TrimLock	L15 1,500lm	9 90	30 3000K	CP Chicago plenum (CCEA) ⁽⁵⁾
	L20 2,000lm		35 3500K	
	L30 3,000lm		40 4000K	
	L40 4,000lm			
	L50 5,000lm ⁽³⁾			

TRIM

TRIM TYPE	DISTRIBUTION ⁽⁶⁾	FLANGE TYPE	REFLECTOR FINISH	TRIM OPTIONS
L Flush lens	W 85° Wide M 35° Medium N 25° Narrow	OF 1/2" standard flange SF 1/4" mud-in flange ⁽⁷⁾	CS Clear semi-specular powder coat WH White texture powder coat BL Black texture powder coat	IP IP65 rated trim AD Diffuse acrylic lens ⁽⁸⁾ PD Diffuse 1/8" polycarbonate lens ⁽⁹⁾ WET/CC Wet location, covered ceiling listed ⁽¹⁰⁾

MOUNTING

MOUNTING TYPE⁽¹¹⁾

- N** Open pan for new construction
- I** IC-rated enclosure for new construction⁽¹³⁾

MOUNTING HARDWARE⁽¹²⁾

- F1M** 2-Position fixed pan bracket, aluminum, universal bar hanger included
- BA1M** Adjustable butterfly pan bracket, aluminum, bar hanger not included⁽¹⁴⁾
- CA1M** Adjustable caterpillar pan bracket, aluminum, universal bar hanger included

REMOTE DRIVER ENCLOSURE (ORDERED SEPARATELY)⁽¹⁵⁾

ORDERING EXAMPLE: M6PR - RDB1 - L10 - OPTIONS - DIM - UNV

SERIES	DRIVER BOX	DRIVER QTY.	LUMENS	OPTIONS	DRIVER ⁽¹⁶⁾	VOLTAGE
M6PR	RDB Remote driver enclosure	1 7	L10 1,000lm	EM/12W 12-watt emergency battery ⁽¹⁸⁾	DIM Dimming driver, 0-10V	UNV 120-277V
		2 8	L15 1,500lm			
		3 9	L20 2,000lm	F Fuse kit	DIM1 1% Dimming driver, 0-10V	
		4 10	L30 3,000lm			
		5 11	L40 4,000lm	SDT Stepdown transformer ⁽¹⁹⁾		
		6 12	L50 5,000lm ⁽¹⁷⁾			

NOTES

- Housing, trim, and mounting ship separately.
- Lumen output based on W distribution and WH finish, 3500K/80CRI. Actual lumens may vary +/-5%, see page 2 for FIXTURE PERFORMANCE DATA.
- Available with RDB1 only.
- I Mounting Type required.
- I Mounting Type required.
- Beam angle based on WH reflector finish.
- For use with mud-in plaster construction only, supplied with mud flange installation kit, see page 3 for FLANGE TYPE DETAILS, not available with ATH, CP or IP options.
- Wide distribution only.
- Wide distribution only.
- Reduces lumen output, use .85 multiplier.

- Mounting hardware required, ordered separately, see MOUNTING HARDWARE ordering info. See page 3 for MOUNTING TYPE DETAILS.
- See page 4 for MOUNTING HARDWARE DETAILS.
- L30 lumen package max.
- N Mounting Type only.
- Required. Ordered as a separate catalog number, ships separately. See page 4 for REMOTE DRIVER ENCLOSURE DETAILS.
- All drivers dimmed by single control signal. See page 3 for ADDITIONAL DRIVER OPTIONS.
- Available with RDB1 only.
- Available with RDB1 only.
- May be required for 347V, see product builder at hew.com
- Not available with EM batteries.



M6PR LED 6" MRI Shallow Plenum Downlight – Round

FIXTURE PERFORMANCE DATA

LED PACKAGE	DISTRIBUTION	DELIVERED LUMENS	WATTAGE	EFFICACY (lm/W)
L10	W	1111	10.7	103.6
	M	1127	10.7	105.1
	N	1137	10.7	106.1
L15	W	1696	16.6	101.9
	M	1720	16.6	103.3
	N	1736	16.6	104.3
L20	W	2208	22.7	97.3
	M	2239	22.7	98.8
	N	2260	22.7	99.7
L30	W	3293	33.2	99.1
	M	3309	33.2	99.6
	N	3224	33.2	97.1
L40	W	4394	44.1	99.6
	M	4415	44.1	100.1
	N	4302	44.1	97.6
L50	W	5503	54.7	100.7
	M	5529	54.7	101.2
	N	5388	54.7	98.6

MULTIPLIER TABLES

COLOR TEMPERATURE		
	CCT	CONVERSION FACTOR
	80 CRI	2700K
3000K		0.96
3500K		1.00
4000K		1.01

90 CRI	2700K	0.74
	3000K	0.85
	3500K	0.90
	4000K	0.91

- Photometrics tested in accordance with IESNA LM-79. Results shown are based on 25°C ambient temperature.
- Wattage shown is based on 120V input.
- Results based on 3500K, 80 CRI, actual lumens may vary +/-5%
- Use multiplier table to calculate additional options.

PHOTOMETRY

M6PR-TL-L20/835-LW-OF-WH Total Luminaire Output: 2208 lumens; 22.7 Watts | Efficacy: 97.3 lm/W | 81.8 CRI; 3647K CCT

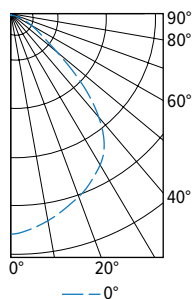

CANDLEPOWER DISTRIBUTION	VERTICAL ANGLE	HORIZONTAL ANGLE	ZONAL LUMENS
		0°	
	0	1169	
	5	1148	81
	15	1075	174
	25	989	243
	35	859	267
	45	556	183
	55	223	86
	65	111	47
	75	51	21
	85	12	3
	90	1	

LUMEN SUMMARY	ZONE	LUMENS	% FIXTURE
	0 - 40	1399	64
	0 - 60	2029	92
	0 - 90	2208	100
	0 - 180	2208	100

M6PR-TL-L20/835-LM-OF-WH Total Luminaire Output: 2239 lumens; 22.7 Watts | Efficacy: 98.8 lm/W | 81.7 CRI; 3644K CCT

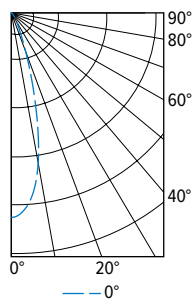

CANDLEPOWER DISTRIBUTION	VERTICAL ANGLE	HORIZONTAL ANGLE	ZONAL LUMENS
		0°	
	0	5151	
	5	4950	333
	15	3241	421
	25	1025	188
	35	304	80
	45	134	46
	55	70	27
	65	36	15
	75	17	7
	85	3	1
	90	0	

LUMEN SUMMARY	ZONE	LUMENS	% FIXTURE
	0 - 40	2013	90
	0 - 60	2182	97
	0 - 90	2239	100
	0 - 180	2239	100

M6PR-TL-L20/835-LN-OF-WH Total Luminaire Output: 2260 lumens; 22.7 Watts | Efficacy: 99.7 lm/W | 81.6 CRI; 3629K CCT

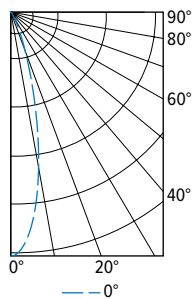

CANDLEPOWER DISTRIBUTION	VERTICAL ANGLE	HORIZONTAL ANGLE	ZONAL LUMENS
		0°	
	0	8348	
	5	7547	466
	15	3235	381
	25	771	137
	35	212	57
	45	107	38
	55	66	27
	65	37	16
	75	16	7
	85	3	1
	90	0	

LUMEN SUMMARY	ZONE	LUMENS	% FIXTURE
	0 - 40	2060	91
	0 - 60	2203	98
	0 - 90	2260	100
	0 - 180	2260	100



M6PR^{LED} 6" MRI Shallow Plenum Downlight – Round

TRIMLOCK DETAILS



FLANGE TYPE DETAILS

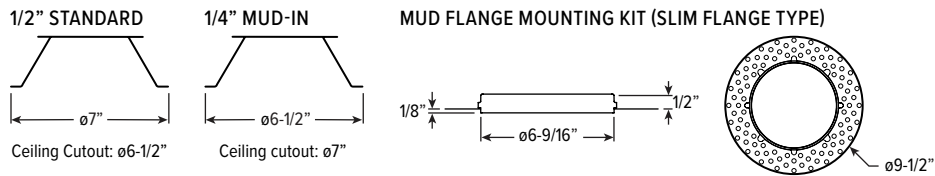

REFLECTOR FINISH DETAILS

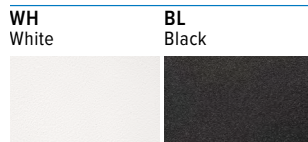

MOUNTING TYPE DETAILS

NEW CONSTRUCTION

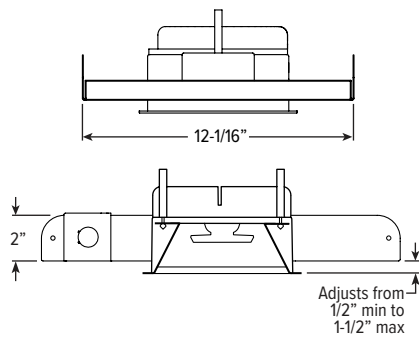

IC-RATED

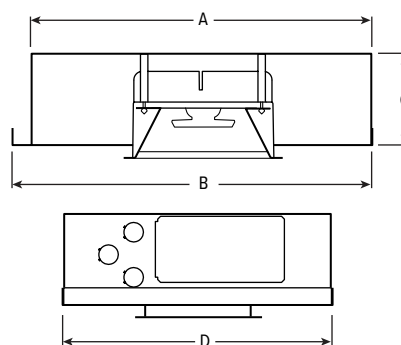

LUMENS	LENGTH			
	A	B	C	D
L10 - L30	15-3/16"	16"	4-1/8"	12-1/8"

ADDITIONAL DRIVER OPTIONS

Lumen restrictions apply: L30 max for DMX driver, L30 max for Lutron drivers. 347V may require stepdown transformer, see product builder at hew.com.

CATALOG NUMBER	DESCRIPTION
DIM	Dimming driver prewired for 0-10V low voltage applications
DIM1	1% dimming driver prewired for 0-10V low voltage applications
DMX	0.1% dimming driver for DMX controls
LTE LINE	Lutron Hi-Lume® A-Series 1% dimming driver for forward phase line voltage controls (120V only)
LDE1	Lutron EcoSystem® H-Series 1% dimming driver for EcoSystem® controls
LDE5	Lutron EcoSystem® 5-Series 5% dimming driver for EcoSystem® controls
ELDO SOLOB	EldoLED Solodrive, 0.1% dimming driver for 0-10V controls
ELDO SOLOB DALI	EldoLED Solodrive, 0.1% dimming driver for DALI controls
ELDO ECO1	EldoLED Ecodrive, 1% dimming driver for 0-10V controls
ELDO ECO1 DALI	EldoLED Ecodrive, 1% dimming driver for DALI controls

M6PR^{LED} 6" MRI Shallow Plenum Downlight – Round

MOUNTING HARDWARE DETAILS

F1M 2-Position fixed pan bracket, aluminum, universal bar hanger included

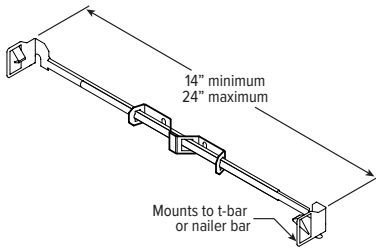

BA1M Adjustable butterfly pan bracket, aluminum, bar hanger not included

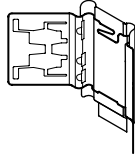

CA1M Adjustable caterpillar pan bracket, aluminum, universal bar hanger included

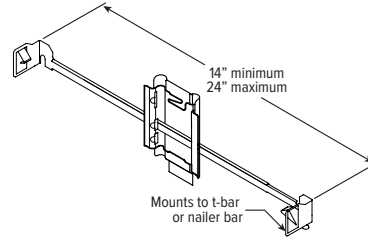

REMOTE DRIVER ENCLOSURE DETAILS (ORDERED & SHIPPED SEPARATELY)

Remote driver enclosure for single fixture

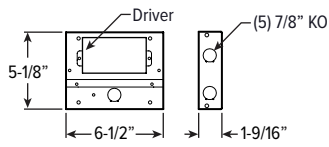

Remote driver enclosure for single fixture with EM/12W

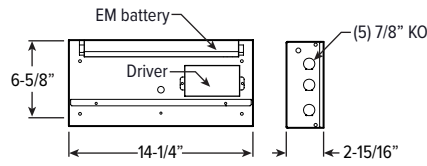

Remote driver enclosure for 2 - 8 fixtures

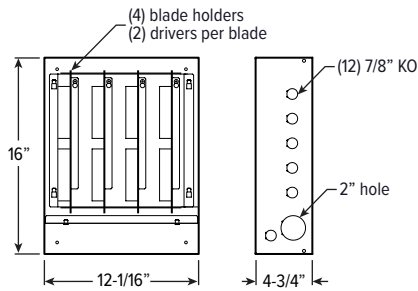

Remote driver enclosure for 9 - 12 fixtures

