

M6PS LED 6" MRI Shallow Plenum Downlight – Square

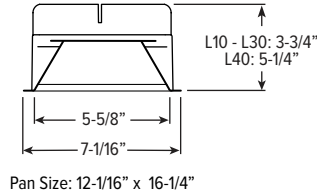

CATALOG #: _____

TYPE: _____

PROJECT: _____

FEATURES

- Designed with non-ferrous materials for MRI imaging suites
- IP65-rated die-cast trim includes easy-to-clean flush lens
- Slim 5" depth for minimal plenum space applications
- Beam angles ranging from 30° narrow to 85° wide for tailored performance
- Square shape accentuates architectural styles
- Spring clip retention system eliminates trim sag
- Contemporary design provides glare-free illumination for a soft ceiling appearance
- Industry-leading efficacies as high as 102 lm/W
- Fully room-side accessible

SPECIFICATIONS

- HOUSING** – Spun housing with forged aluminum heat sink. Aluminum splice compartment. Trim housing adjusts for ceiling thickness from 1/2" - 1-1/2".
- LENSED TRIM** – Die-cast aluminum frame with micro-prismatic, tempered glass lens.
- ELECTRICAL** – High-performance Class 2 C.O.B. LED array. Modular quick-connect plug for easy field-connection of LED light assembly to splice compartment. Reported L70>55,000 hours. Reported L90>50,000 hours. Estimated L70 = 200,000 hours.
- MOUNTING** – Recessed. Aluminum mounting pan for new construction or IC-rated enclosure. Marked spacing restrictions apply for L40 and L50, consult factory. Remote mounted driver enclosure required, ordered separately, must be located outside MRI room.
- LISTINGS** –
 - cCSAus conforms to UL STD 1598; Certified to CAN/CSA STD C22.2 No. 250.0 for damp locations. LED light assembly conforms to UL 2108 for remote installation.
 - Suitable for wet location under covered ceiling when specified with WET/CC option.
 - IC-rated for direct contact with insulation when specified with I Mounting Type.
 - City of Chicago Environmental Air approved when specified with CP option.
 - Complies with ASTM-E283 when specified with ATH option.
 - RoHS compliant.
- WARRANTY** – 5-year limited warranty, see hew.com/warranty.

ORDERING EXAMPLE:^[1] **M6PS - L40/835 - OPTIONS** - **LW - OF - WH - TRIM OPTIONS** - **N - F1M**
 HOUSING TRIM MOUNT.

HOUSING

SERIES	LUMENS ^[2]	CRI	CCT	OPTIONS
M6PS	L10 1,000lm	8 80	27 2700K	ATH Airtight construction ^[4]
	L15 1,500lm	9 90	30 3000K	CP Chicago plenum (CCEA) ^[5]
	L20 2,000lm		35 3500K	
	L30 3,000lm		40 4000K	
	L40 4,000lm			
L50 5,000lm ^[3]				

TRIM

TRIM TYPE	DISTRIBUTION ^[6]	FLANGE TYPE	REFLECTOR FINISH	TRIM OPTIONS
L Flush lens	W 85° Wide	OF 1/2" standard flange	WH White texture powder coat	IP IP65 rated trim
	M 35° Medium		BL Black texture powder coat	AD Diffuse acrylic lens ^[8]
	N 30° Narrow	SF 1/4" mud-in flange ^[7]		WET/CC Wet location, covered ceiling listed

MOUNTING

MOUNTING TYPE ^[9]	MOUNTING HARDWARE ^[10]
N Open pan for new construction	F1M 2-Position fixed pan bracket, aluminum, universal bar hanger included
I IC-rated enclosure for new construction ^[11]	BA1M Adjustable butterfly pan bracket, aluminum, bar hanger not included ^[12]
	CA1M Adjustable caterpillar pan bracket, aluminum, universal bar hanger included

REMOTE DRIVER ENCLOSURE (ORDERED SEPARATELY)^[13]

ORDERING EXAMPLE: **M6PS - RDB1 - L40 - OPTIONS - DIM - UNV**

SERIES	DRIVER BOX	DRIVER QTY.	LUMENS	OPTIONS	DRIVER ^[14]	VOLTAGE
M6PS	RDB Remote driver enclosure	1 7	L10 1,000lm	EM/12W 12-watt emergency battery ^[16]	DIM Dimming driver, 0-10V	UNV 120-277V
		2 8	L15 1,500lm			
		3 9	L20 2,000lm	F Fuse kit	DIM1 1% Dimming driver, 0-10V	
		4 10	L30 3,000lm			
		5 11	L40 4,000lm			SDT Stepdown transformer ^[17]
		6 12	L50 5,000lm ^[15]			

NOTES

- Housing, trim, and mounting ship separately.
- Lumen output based on W distribution and WH finish, 3500K/80CRI. Actual lumens may vary +/-5%, see page 2 for FIXTURE PERFORMANCE DATA.
- Available with RDB1 only.
- I Mounting Type required.
- I Mounting Type required.
- Beam angle based on WH reflector finish.
- For use with mud-in plaster construction only, supplied with mud flange installation kit, see page 3 for FLANGE TYPE DETAILS, not available with ATH, CP or IP options.
- Wide distribution only.
- Mounting hardware required, ordered separately, see MOUNTING HARDWARE ordering info. See page 3 for MOUNTING TYPE DETAILS.
- See page 4 for MOUNTING HARDWARE DETAILS.
- L30 lumen package max.
- N Mounting Type only.
- Required. Ordered as a separate catalog number, ships separately. See page 4 for REMOTE DRIVER ENCLOSURE DETAILS.
- All drivers dimmed by single control signal.
- Available with RDB1 only.
- Available with RDB1 only.
- May be required for 347V, see product builder at hew.com.
- Not available with EM batteries.



M6PS^{LED} 6" MRI Shallow Plenum Downlight – Square

FIXTURE PERFORMANCE DATA

LED PACKAGE	DISTRIBUTION	DELIVERED LUMENS	WATTAGE	EFFICACY (lm/W)
L10	W	1067	10.7	99.5
	M	1012	10.7	94.4
	N	971	10.7	90.6
L15	W	1643	17.2	95.4
	M	1558	17.2	90.5
	N	1495	17.2	86.8
L20	W	2139	23.5	91.1
	M	2029	23.5	86.4
	N	1947	23.5	82.9
L30	W	3222	33.2	97.0
	M	3056	33.2	92.0
	N	2932	33.2	88.3
L40	W	4509	44.5	101.3
	M	4284	44.5	96.3
	N	4107	44.5	92.3
L50	W	5387	54.7	98.6

MULTIPLIER TABLES

COLOR TEMPERATURE		
	CCT	CONVERSION FACTOR
	80 CRI	2700K
3000K		0.96
3500K		1.00
4000K		1.01
90 CRI	2700K	0.74
	3000K	0.85
	3500K	0.90
	4000K	0.91

- Photometrics tested in accordance with IESNA LM-79. Results shown are based on 25°C ambient temperature.
- Wattage shown is based on 120V input.
- Results based on L trim type, W distribution and WH finish, 3500K/80CRI, actual lumens may vary +/-5%
- Use multiplier table to calculate additional options.

PHOTOMETRY

M6PS-L40/835-DIM-UNV-LW-OF-WH Total Luminaire Output: 4509 lumens; 44.5 Watts | Efficacy: 101.3 lm/W | 82.9 CRI; 3419K CCT

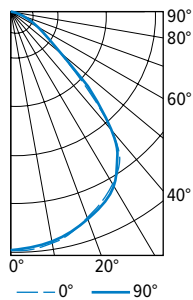

CANDLEPOWER DISTRIBUTION	VERTICAL ANGLE	HORIZONTAL ANGLE			ZONAL LUMENS
		0°	45°	90°	
	0	2230	2230	2230	
	5	2230	2218	2211	212
	15	2150	2134	2140	607
	25	1999	1979	1995	921
	35	1774	1772	1731	1109
	45	1058	1336	1048	915
	55	400	627	385	431
	65	192	232	193	207
	75	84	90	85	92
	85	17	15	17	16
	90	0	0	0	

LUMEN SUMMARY	ZONE	LUMENS	% FIXTURE
	0 - 30	1739	39
	0 - 40	2848	63
	0 - 60	4194	93
	0 - 90	4509	100
	0 - 180	4509	100

M6PS-L40/835-DIM-UNV-LM-OF-WH Total Luminaire Output: 4284 lumens; 44.5 Watts | Efficacy: 96.3 lm/W | 82.9 CRI; 3419K CCT

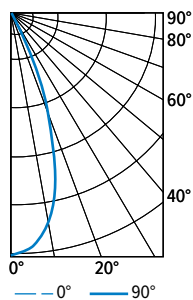

CANDLEPOWER DISTRIBUTION	VERTICAL ANGLE	HORIZONTAL ANGLE			ZONAL LUMENS
		0°	45°	90°	
	0	8786	8786	8786	
	5	8610	8552	8496	816
	15	6039	6091	6127	1724
	25	1971	2066	2061	946
	35	589	621	623	388
	45	247	264	262	201
	55	125	139	125	117
	65	61	68	61	63
	75	25	26	25	247
	85	3	4	3	3
	90	0	0	0	

LUMEN SUMMARY	ZONE	LUMENS	% FIXTURE
	0 - 30	3486	81
	0 - 40	3874	90
	0 - 60	4192	98
	0 - 90	4284	100
	0 - 180	4284	100

M6PS-L40/835-DIM-UNV-LN-OF-WH Total Luminaire Output: 4107 lumens; 44.5 Watts | Efficacy: 92.3 lm/W | 82.9 CRI; 3419K CCT

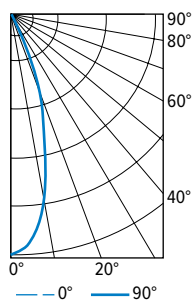

CANDLEPOWER DISTRIBUTION	VERTICAL ANGLE	HORIZONTAL ANGLE			ZONAL LUMENS
		0°	45°	90°	
	0	9954	954	9954	
	5	9466	9392	9386	899
	15	5533	5584	5550	1535
	25	1726	1843	1812	838
	35	513	540	550	337
	45	243	265	262	199
	55	151	172	156	145
	65	83	93	86	88
	75	31	35	31	35
	85	2	3	3	3
	90	0	0	0	

LUMEN SUMMARY	ZONE	LUMENS	% FIXTURE
	0 - 30	3301	80
	0 - 40	3638	89
	0 - 60	3981	97
	0 - 90	4107	100
	0 - 180	4107	100



M6PS^{LED} 6" MRI Shallow Plenum Downlight – Square

FLANGE TYPE DETAILS

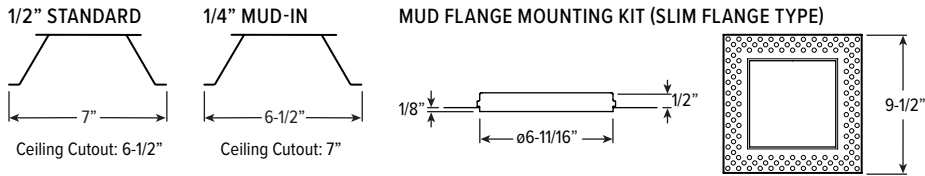

REFLECTOR FINISH DETAILS

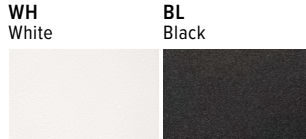

MOUNTING TYPE DETAILS

NEW CONSTRUCTION

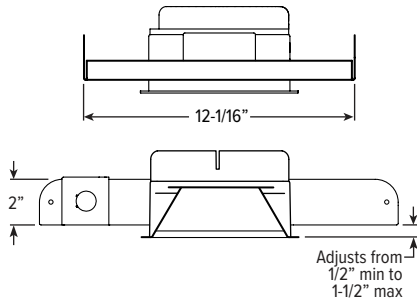

IC-RATED

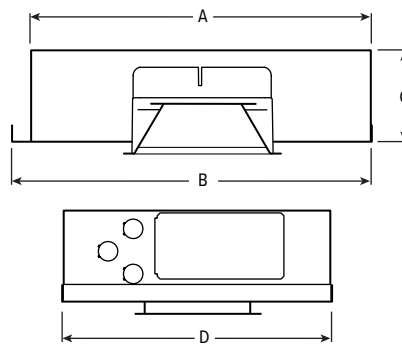

LUMENS	LENGTH			
	A	B	C	D
L10 - L30	15-3/16"	16"	4-1/8"	12-1/8"

ADDITIONAL DRIVER OPTIONS

Lumen restrictions apply and 347V may require stepdown transformer, see product builder at hew.com.

CATALOG NUMBER	DESCRIPTION
DIM	Dimming driver prewired for 0-10V low voltage applications
DIM1	1% dimming driver prewired for 0-10V low voltage applications
DMX	0.1% dimming driver for DMX controls
LTE LINE	Lutron Hi-Lume® A-Series 1% dimming driver for forward phase line voltage controls (120V only)
LDE1	Lutron EcoSystem® H-Series 1% dimming driver for EcoSystem® controls
LDE5	Lutron EcoSystem® 5-Series 5% dimming driver for EcoSystem® controls
ELDO SOLOB	EldoLED Solodrive, 0.1% dimming driver for 0-10V controls
ELDO SOLOB DALI	EldoLED Solodrive, 0.1% dimming driver for DALI controls
ELDO ECO1	EldoLED Ecodrive, 1% dimming driver for 0-10V controls
ELDO ECO1 DALI	EldoLED Ecodrive, 1% dimming driver for DALI controls

M6PS^{LED} 6" MRI Shallow Plenum Downlight – Square

MOUNTING HARDWARE DETAILS

F1M 2-Position fixed pan bracket, aluminum, universal bar hanger included

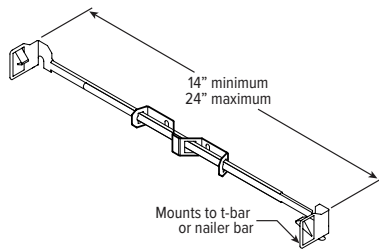

BA1M Adjustable butterfly pan bracket, aluminum, bar hanger not included

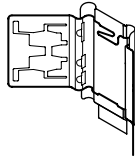

CA1M Adjustable caterpillar pan bracket, aluminum, universal bar hanger included

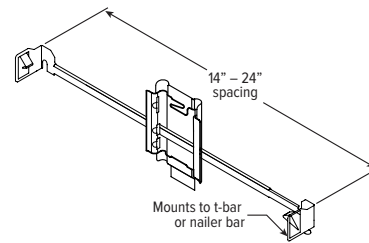

REMOTE DRIVER ENCLOSURE DETAILS (ORDERED & SHIPPED SEPARATELY)

Remote driver enclosure for single fixture

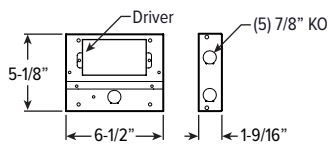

Remote driver enclosure for single fixture with EM/12W

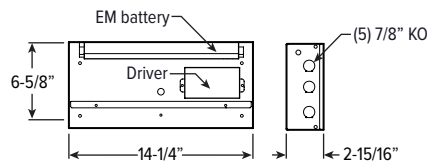

Remote driver enclosure for 2 - 8 fixtures

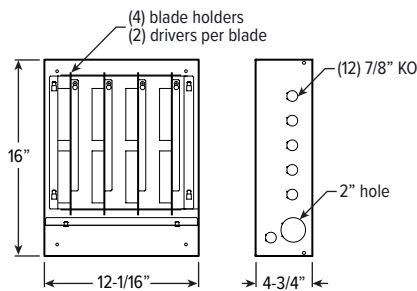

Remote driver enclosure for 9 - 12 fixtures

