

4AR dim to WARM

4.5" Adjustable Downlight – Round

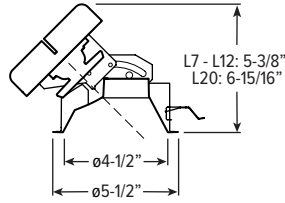

CATALOG #: _____

TYPE: _____

PROJECT: _____

NEW CONSTRUCTION AND REMODEL

FEATURES

- Dim to warm from 1800K to 3000K CCT, minimum 95 CRI
- Adjustable aim with 0° - 45° tilt and 360° rotation
- Etched degree markers and directional indicator make it simple to fine-tune the illumination angle
- 4 inch aperture is unobtrusive in small scale spaces
- Spring clip retention system eliminates trim sag
- Choice of open reflector or die-cast lensed trims to complement interior style
- Contemporary design provides glare-free illumination for a soft ceiling appearance
- Fully room-side accessible

SPECIFICATIONS

- **HOUSING** – Die-cast aluminum spun and stamped articulating mechanism with forged aluminum heat sink. Galvanized steel splice compartment with driver mounting plate/enclosure. Mounting clips allow for ceiling thickness from 1/2" - 7/8" (consult factory for additional ceiling thicknesses).
- **OPEN REFLECTOR** – Low-iridescent anodized aluminum. Clear semi-specular finish standard.
- **LENSED TRIM** – Die-cast aluminum frame with micro-prismatic, tempered glass lens.
- **ELECTRICAL** – Five color, mid-power LED modules. On board thermal and optical feedback ensure color consistency of <math>< 2</math> step MacAdam ellipse (SDCM). In-line spectral capture and storage results in consistent CRI and CCT across all arrays. Reported L70>55,000 hours. Reported L90>55,000 hours. Estimated L70 = 200,000 hours.
- **MOUNTING** – Recessed. 20 ga. galvanized steel mounting pan for new construction or IC-rated enclosure. Remodel kit option includes receiver bracket hardware. N and R mounting types for use in non-fire rated installations only.
- **LISTINGS** –
 - cCSAus conforms to UL STD 1598; Certified to CAN/CSA STD C22.2 No. 250.0 for damp locations. LED light assembly conforms to UL 2108 for remote installation.
 - IC-rated for direct contact with insulation when specified with I Mounting Type.
 - City of Chicago Environmental Air approved when specified with CP option.
 - Complies with ASTM-E283 when specified with ATH option.
 - RoHS compliant.
- **WARRANTY** – 5-year limited warranty, see hew.com/warranty.

ORDERING EXAMPLE:⁽¹⁾ **4AR - L20/9DW - OPTIONS - DIM - UNV - OW - OF - CS - TRIM OPTIONS - N - F1**

HOUSING TRIM MOUNT.

HOUSING

SERIES	LUMENS ⁽²⁾	COLOR	OPTIONS	CONTROL	VOLTAGE
4AR	L7 700lm	9DW Dim to warm (95 CRI, 1800K – 3000K)	EM/10W 10-watt emergency battery ⁽³⁾	DIM Dimming driver (0-10V signal to control dimming and CCT)	UNV 120-277V 347 347V ⁽⁷⁾
	L12 1,200lm		ATH Airtight construction ⁽⁴⁾		
	L20 2,000lm		CP Chicago plenum (CCEA) ⁽⁵⁾		
			F Fuse kit	LUT Lutron Ecosystem enabled	
			SDT Stepdown transformer ⁽⁶⁾		

TRIM

TRIM TYPE	DISTRIBUTION ⁽⁸⁾	FLANGE TYPE	REFLECTOR FINISH	TRIM OPTIONS
O Open reflector	W Wide	OF 1/2" standard flange	Open trim types	MWT Textured white trim flange ⁽¹¹⁾
L Flush lens	45° Open	SF 1/4" mud-in flange ⁽¹⁰⁾	CS Clear semi-specular anodize	AD Diffuse acrylic lens ⁽¹²⁾
A Angled lens	40° Flush		WH White texture powder coat	PD Diffuse 1/8" polycarbonate lens ⁽¹³⁾
	30° Angled		BL Black texture powder coat	
	M Medium		Lens trim types	
	30° Open		CS Clear semi-specular powder coat	
	30° Flush		WH White texture powder coat	
	25° Angled		BL Black texture powder coat	
	N Narrow ⁽⁹⁾			
	25° Flush			
	25° Angled			

MOUNTING

MOUNTING TYPE⁽¹⁴⁾

- N Open pan for new construction
- I IC-rated enclosure for new construction⁽¹⁶⁾
- R Remodel kit⁽¹⁷⁾

MOUNTING HARDWARE⁽¹⁵⁾

- F1 2-Position fixed pan bracket, universal bar hanger included
- F2 2-Position fixed pan bracket, t-bar bar hanger included
- BA1 Adjustable butterfly pan bracket, bar hanger not included⁽¹⁸⁾
- BA2 Adjustable butterfly pan bracket, heavy-duty universal bar hanger included⁽¹⁹⁾
- CA1 Adjustable caterpillar pan bracket, universal bar hanger included
- CA2 Adjustable caterpillar pan bracket, t-bar hanger included

NOTES

- Housing, trim, and mounting ship separately.
- Lumen output based on full light output, O trim type, N distribution and CS finish, 3000K/95CRI. Actual lumens may vary +/-5%, see page 2 for FIXTURE PERFORMANCE DATA.
- N Mounting Type only.
- I Mounting Type required.
- I Mounting Type required.
- May be required for 347V, see product builder at hew.com
- Not available with EM batteries.
- Beam angle based on CS or WH reflector finish.
- L and A Trim Types only.
- For use with mud-in plaster construction only, supplied with mud flange installation kit, see page 4 for FLANGE TYPE DETAILS, not available with CP or ATH option.
- O Trim Type and OF Flange Type only. Not available with WH Reflector Finish.
- L and A Trim Types only. Wide distribution only.
- L and A Trim Types only. Wide distribution only.
- Mounting hardware required (N and I only), ordered separately, see MOUNTING HARDWARE ordering info. See page 4 for MOUNTING TYPE DETAILS.
- Specify for N and I Mounting Types only. See page 4 for MOUNTING HARDWARE DETAILS.
- L12 lumen package max.
- Also used in new construction sheetrock ceilings.
- N Mounting Type only.
- N Mounting Type only.

4AR dim to WARM

4.5" Adjustable Downlight – Round

FIXTURE PERFORMANCE DATA

OPEN REFLECTOR TRIM TYPE

LED PACKAGE	DISTRIBUTION	DELIVERED LUMENS	CCT AT 100% (FULL OUTPUT)	CCT AT 1% (FULL DIM)	WATTAGE	EFFICACY (lm/W)
L7	W	466	3000K	1800K	14.0	37.3
	M	648			14.0	46.1
L12	W	818			23.4	35.0
	M	1136			23.4	48.6
L20	W	1339			37.7	35.5
	M	1860			37.7	49.4

FLUSH LENS TRIM TYPE

LED PACKAGE	DISTRIBUTION	DELIVERED LUMENS	CCT AT 100% (FULL OUTPUT)	CCT AT 1% (FULL DIM)	WATTAGE	EFFICACY (lm/W)
L7	W	462	3000K	1800K	14.0	33.0
	M	625			14.0	44.7
	N	656			14.0	46.8
L12	W	811			23.4	34.7
	M	1096			23.4	46.9
	N	1149			23.4	49.2
L20	W	1327	37.7	35.2		
	M	1796	37.7	47.7		
	N	1882	37.7	50.0		

ANGLED LENS TRIM TYPE

LED PACKAGE	DISTRIBUTION	DELIVERED LUMENS	CCT AT 100% (FULL OUTPUT)	CCT AT 1% (FULL DIM)	WATTAGE	EFFICACY (lm/W)
L7	W	330	3000K	1800K	14.0	23.6
	M	483			14.0	34.5
	N	586			14.0	41.9
L12	W	578			23.4	24.7
	M	846			23.4	36.2
	N	1027			23.4	44.0
L20	W	947	37.7	25.1		
	M	1386	37.7	36.8		
	N	1682	37.7	44.7		

OPEN REFLECTOR FINISH		
CATALOG NUMBER	REFLECTOR FINISH	CONVERSION FACTOR
CS	Clear semi-specular	1.00
WH	White, textured	0.89
BL	Black, textured	0.79

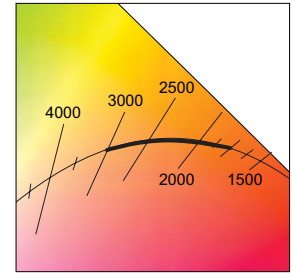

- Photometrics tested in accordance with IESNA LM-79. Results shown are based on 25°C ambient temperature.
- Wattage shown is based on 120V input.
- Results based on 3000K, 95 CRI, full output, 0° tilt, actual lumens may vary +/-5%
- Use multiplier table to calculate additional options.

PHOTOMETRY

4AR-L20/9DW-DIM-UNV-OW-OF-CS (25° tilt) Total Luminaire Output: 1355 lumens; 37.7 Watts | Efficacy: 35.9 lm/W | 95.0 CRI; 3000K CCT

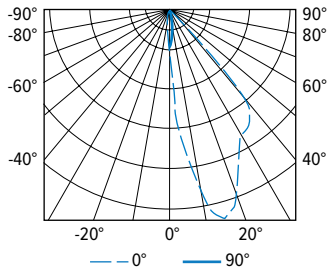

VERTICAL ANGLE	HORIZONTAL ANGLE					ZONAL LUMENS
	0°	45°	90°	135°	180°	
0	788	788	788	788	788	
5	2389	1675	653	270	195	97
15	4321	2360	253	61	40	319
25	3255	2150	64	17	15	425
35	2817	991	12	8	11	399
45	582	30	5	4	3	112
55	6	0	0	0	3	2
65	1	0	0	0	0	0
75	0	0	0	0	0	0
85	0	0	0	0	0	0
90	0	0	0	0	0	0

LUMEN SUMMARY	ZONE	LUMENS	% FIXTURE
	0 - 40	1240	92
	0 - 60	1354	100
	0 - 90	1355	100
	0 - 180	1355	100

4AR-L20/9DW-DIM-UNV-OM-OF-CS (25° tilt) Total Luminaire Output: 1677 lumens; 37.7 Watts | Efficacy: 44.5 lm/W | 95.0 CRI; 3000K CCT

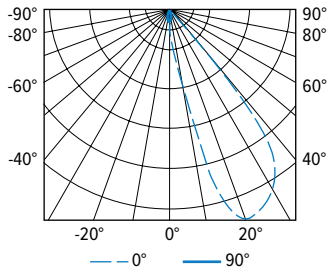

VERTICAL ANGLE	HORIZONTAL ANGLE					ZONAL LUMENS
	0°	45°	90°	135°	180°	
0	410	410	410	410	410	
5	1166	777	365	197	161	55
15	5878	1449	183	60	35	332
25	6732	1472	69	13	11	621
35	5563	632	10	0	0	558
45	641	32	0	0	0	109
55	6	0	0	0	0	2
65	0	0	0	0	0	0
75	0	0	0	0	0	0
85	0	0	0	0	0	0
90	0	0	0	0	0	0

LUMEN SUMMARY	ZONE	LUMENS	% FIXTURE
	0 - 40	1566	93
	0 - 60	1677	100
	0 - 90	1677	100
	0 - 180	1677	100



4AR dim to WARM

4.5" Adjustable Downlight – Round

4AR-L20/9DW-DIM-UNV-LN-OF-CS (25° tilt) Total Luminaire Output: 1806 lumens; 37.7 Watts | Efficacy: 47.9 lm/W | 95.0 CRI; 4037K CCT

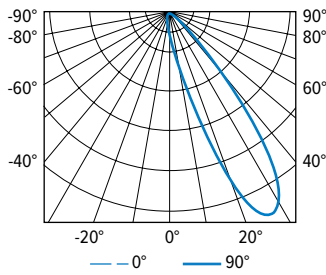

VERTICAL ANGLE	HORIZONTAL ANGLE					ZONAL LUMENS
	0°	45°	90°	135°	180°	
0	306	306	306	306	306	
5	871	663	297	152	129	45
15	3783	1461	184	71	69	266
25	6802	1557	86	58	64	589
35	4947	786	42	45	55	544
45	1442	212	26	41	56	242
55	353	57	19	36	52	77
65	61	22	13	25	40	30
75	18	8	6	12	21	12
85	0	0	0	0	0	1
90	0	0	0	0	0	

LUMEN SUMMARY	ZONE	LUMENS	% FIXTURE
	0 - 40	1444	80
	0 - 60	1764	98
	0 - 90	1806	100
	0 - 180	1806	100

4AR-L20/9DW-DIM-UNV-LM-OF-WH (25° tilt) Total Luminaire Output: 1618 lumens; 37.7 Watts | Efficacy: 42.9 lm/W | 95.0 CRI; 3000K CCT

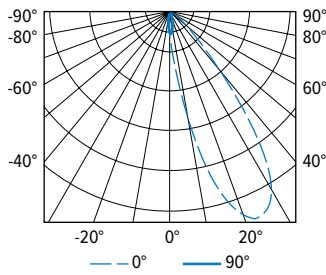

VERTICAL ANGLE	HORIZONTAL ANGLE					ZONAL LUMENS
	0°	45°	90°	135°	180°	
0	494	494	494	494	494	
5	1224	939	464	254	206	63
15	3980	1723	286	113	98	295
25	5194	1668	134	79	85	521
35	3408	736	69	78	96	429
45	954	182	51	81	103	185
55	171	55	39	66	85	72
65	42	22	23	44	58	36
75	16	9	10	20	27	16
85	2	0	0	0	1	2
90	0	0	0	0	0	

LUMEN SUMMARY	ZONE	LUMENS	% FIXTURE
	0 - 40	1308	81
	0 - 60	1564	97
	0 - 90	1618	100
	0 - 180	1618	100

4AR-L20/9DW-DIM-UNV-AN-OF-WH (25° tilt) Total Luminaire Output: 1666 lumens; 37.7 Watts | Efficacy: 44.2 lm/W | 95.0 CRI; 3000K CCT

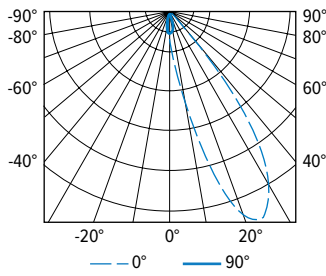

VERTICAL ANGLE	HORIZONTAL ANGLE					ZONAL LUMENS
	0°	45°	90°	135°	180°	
0	297	297	297	297	297	
5	760	621	286	148	119	41
15	3522	1261	168	60	51	246
25	7094	1333	70	36	36	563
35	5685	624	31	25	26	550
45	1638	137	17	20	23	216
55	215	18	10	14	17	42
65	18	6	4	6	6	7
75	4	0	0	0	3	1
85	0	0	0	0	0	0
90	0	0	0	0	0	

LUMEN SUMMARY	ZONE	LUMENS	% FIXTURE
	0 - 40	1400	84
	0 - 60	1658	99
	0 - 90	1666	100
	0 - 180	1666	100

TRIM TYPE DETAILS

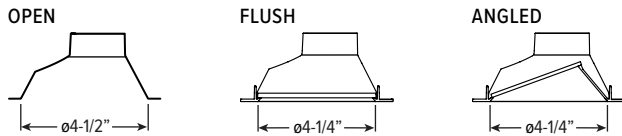

FLANGE TYPE DETAILS

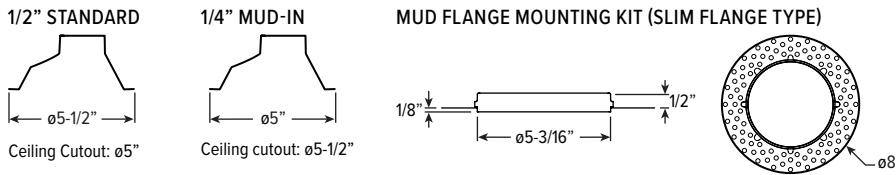

REFLECTOR FINISH DETAILS



4AR dim to WARM

4.5" Adjustable Downlight – Round

MOUNTING TYPE DETAILS

NEW CONSTRUCTION

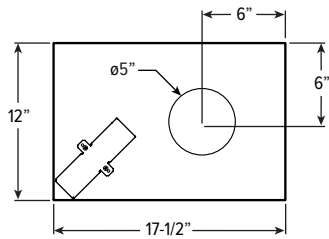

IC-RATED

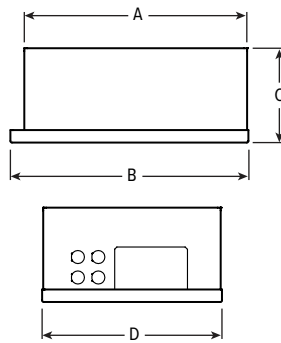

REMODEL

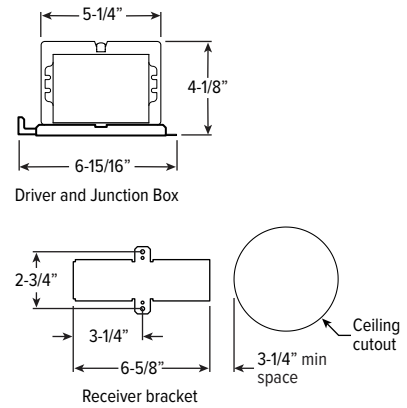

LUMENS	LENGTH			
	A	B	C	D
L7 - L12	15-3/16"	16"	6-3/8"	12-1/8"
L20	16-5/8"	17-1/2"	7-7/8"	14"

MOUNTING HARDWARE DETAILS

F1 2-Position fixed pan bracket, universal bar hanger included

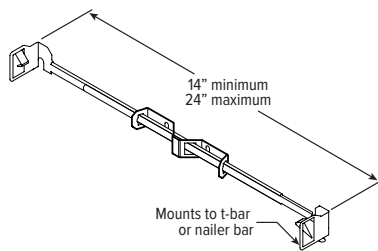

BA1 Adjustable butterfly pan bracket, bar hanger not included

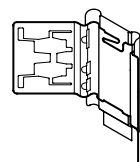

CA1 Adjustable caterpillar pan bracket, universal bar hanger included

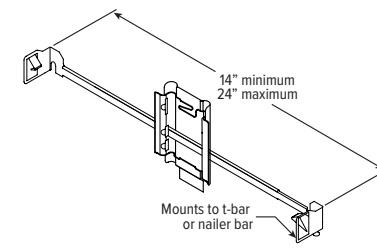

F2 2-Position fixed pan bracket, t-bar bar hanger included

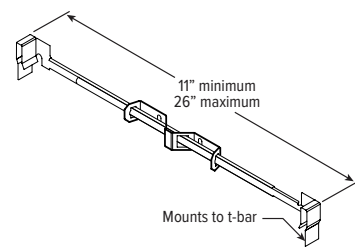

BA2 Adjustable butterfly pan bracket, heavy-duty universal bar hanger included

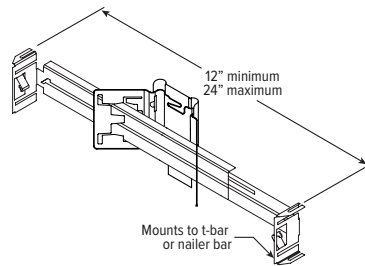

CA2 Adjustable caterpillar pan bracket, t-bar hanger included

