

4AR tunable WHITE

4.5" Adjustable Downlight – Round

FIXTURE PERFORMANCE DATA

OPEN REFLECTOR TRIM TYPE

| LED PACKAGE | DISTRIBUTION | DELIVERED LUMENS | WATTAGE | EFFICACY (lm/W) |
|-------------|--------------|------------------|---------|-----------------|
| L11 | W | 713 | 14.6 | 49.0 |
| | M | 990 | 14.6 | 68.0 |
| L16 | W | 1231 | 24.0 | 51.2 |
| | M | 1652 | 24.0 | 68.7 |
| L30 | W | 2488 | 46.7 | 53.3 |
| | M | 3339 | 46.7 | 71.5 |

FLUSH LENS TRIM TYPE

| LED PACKAGE | DISTRIBUTION | DELIVERED LUMENS | WATTAGE | EFFICACY (lm/W) |
|-------------|--------------|------------------|---------|-----------------|
| L11 | W | 710 | 14.6 | 45.8 |
| | M | 960 | 14.6 | 61.2 |
| | N | 965 | 14.6 | 66.1 |
| L16 | W | 1266 | 24.0 | 46.8 |
| | M | 1650 | 24.0 | 61.8 |
| | N | 1643 | 24.0 | 66.3 |
| L30 | W | 2560 | 46.7 | 48.7 |
| | M | 3336 | 46.7 | 64.3 |
| | N | 3321 | 46.7 | 69.0 |

ANGLED LENS TRIM TYPE

| LED PACKAGE | DISTRIBUTION | DELIVERED LUMENS | WATTAGE | EFFICACY (lm/W) |
|-------------|--------------|------------------|---------|-----------------|
| L11 | W | 506 | 14.6 | 36.6 |
| | M | 741 | 14.6 | 50.9 |
| | N | 900 | 14.6 | 62.2 |
| L16 | W | 923 | 24.0 | 37.3 |
| | M | 1261 | 24.0 | 55.1 |
| | N | 1416 | 24.0 | 59.6 |
| L30 | W | 1867 | 46.7 | 38.8 |
| | M | 2550 | 46.7 | 57.4 |
| | N | 2863 | 46.7 | 62.0 |

MULTIPLIER TABLE

| COLOR TEMPERATURE | | |
|-------------------|--------|-------|
| CCT | LUMENS | WATTS |
| 2700K | 0.83 | 1.03 |
| 3000K | 1.00 | 1.00 |
| 3500K | 0.99 | 0.99 |
| 4000K | 1.00 | 1.00 |
| 5000K | 0.98 | 1.03 |

| OPEN REFLECTOR FINISH | | |
|-----------------------|---------------------|-------------------|
| CATALOG NUMBER | REFLECTOR FINISH | CONVERSION FACTOR |
| CS | Clear semi-specular | 1.00 |
| WH | White, textured | 0.89 |
| BL | Black, textured | 0.79 |

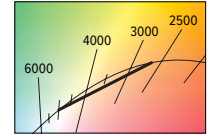

- Photometrics tested in accordance with IESNA LM-79. Results shown are based on 25°C ambient temperature.
- Wattage shown is based on 120V input.
- Results based on 4000K, 80 CRI, 0° tilt, actual lumens may vary +/-5%
- Use multiplier tables to calculate additional options.

PHOTOMETRY

4AR-L11/8TW-DIM-UNV-OW-OF-CS (25° tilt) Total Luminaire Output: 778 lumens; 14.6 Watts | Efficacy: 53.3 lm/W | 80 CRI; 4037K CCT

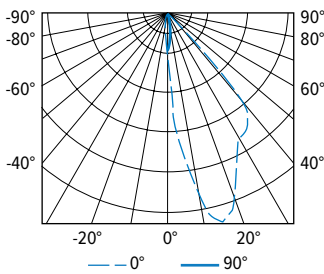

| VERTICAL ANGLE | HORIZONTAL ANGLE | | | | | ZONAL LUMENS |
|----------------|------------------|------|-----|------|------|--------------|
| | 0° | 45° | 90° | 135° | 180° | |
| 0 | 452 | 452 | 452 | 452 | 452 | |
| 5 | 1372 | 962 | 375 | 155 | 112 | 56 |
| 15 | 2482 | 1356 | 145 | 35 | 23 | 183 |
| 25 | 1869 | 1235 | 37 | 10 | 8 | 244 |
| 35 | 1618 | 569 | 7 | 4 | 6 | 229 |
| 45 | 334 | 17 | 3 | 2 | 2 | 64 |
| 55 | 3 | 0 | 0 | 0 | 2 | 1 |
| 65 | 1 | 0 | 0 | 0 | 0 | 0 |
| 75 | 0 | 0 | 0 | 0 | 0 | 0 |
| 85 | 0 | 0 | 0 | 0 | 0 | 0 |
| 90 | 0 | 0 | 0 | 0 | 0 | 0 |

| LUMEN SUMMARY | ZONE | LUMENS | % FIXTURE |
|---------------|---------|--------|-----------|
| | 0 - 40 | 483 | 62 |
| | 0 - 60 | 712 | 91 |
| | 0 - 90 | 778 | 100 |
| | 0 - 180 | 778 | 100 |

4AR-L11/8TW-DIM-UNV-OM-OF-CS (25° tilt) Total Luminaire Output: 963 lumens; 14.6 Watts | Efficacy: 66.0 lm/W | 80 CRI; 4037K CCT

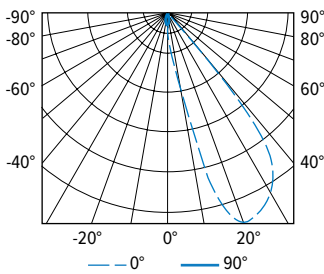

| VERTICAL ANGLE | HORIZONTAL ANGLE | | | | | ZONAL LUMENS |
|----------------|------------------|-----|-----|------|------|--------------|
| | 0° | 45° | 90° | 135° | 180° | |
| 0 | 236 | 236 | 236 | 236 | 236 | |
| 5 | 670 | 446 | 209 | 113 | 92 | 32 |
| 15 | 3376 | 832 | 105 | 35 | 20 | 191 |
| 25 | 3867 | 846 | 40 | 7 | 6 | 356 |
| 35 | 3195 | 363 | 6 | 0 | 0 | 321 |
| 45 | 368 | 18 | 0 | 0 | 0 | 63 |
| 55 | 3 | 0 | 0 | 0 | 0 | 1 |
| 65 | 0 | 0 | 0 | 0 | 0 | 0 |
| 75 | 0 | 0 | 0 | 0 | 0 | 0 |
| 85 | 0 | 0 | 0 | 0 | 0 | 0 |
| 90 | 0 | 0 | 0 | 0 | 0 | 0 |

| LUMEN SUMMARY | ZONE | LUMENS | % FIXTURE |
|---------------|---------|--------|-----------|
| | 0 - 40 | 899 | 93 |
| | 0 - 60 | 963 | 100 |
| | 0 - 90 | 963 | 100 |
| | 0 - 180 | 963 | 100 |



4AR tunable WHITE

4.5" Adjustable Downlight – Round

4AR-L11/8TW-DIM-UNV-LN-OF-WH (25° tilt) Total Luminaire Output: 965 lumens; 14.6 Watts | Efficacy: 66.1 lm/W | 80 CRI; 4037K CCT

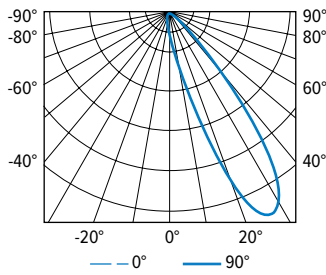

| VERTICAL ANGLE | HORIZONTAL ANGLE | | | | | ZONAL LUMENS |
|----------------|------------------|-----|-----|------|------|--------------|
| | 0° | 45° | 90° | 135° | 180° | |
| 0 | 163 | 163 | 163 | 163 | 163 | |
| 5 | 466 | 354 | 159 | 81 | 69 | 24 |
| 15 | 2021 | 781 | 98 | 38 | 37 | 142 |
| 25 | 3635 | 832 | 46 | 31 | 34 | 315 |
| 35 | 2643 | 420 | 22 | 24 | 29 | 291 |
| 45 | 770 | 113 | 14 | 22 | 30 | 129 |
| 55 | 188 | 30 | 10 | 19 | 28 | 41 |
| 65 | 32 | 12 | 7 | 14 | 21 | 16 |
| 75 | 9 | 4 | 3 | 6 | 11 | 6 |
| 85 | 0 | 0 | 0 | 0 | 0 | 1 |
| 90 | 0 | 0 | 0 | 0 | 0 | |

| LUMEN SUMMARY | ZONE | LUMENS | % FIXTURE |
|---------------|---------|--------|-----------|
| | 0 - 40 | 772 | 80 |
| | 0 - 60 | 942 | 98 |
| | 0 - 90 | 965 | 100 |
| | 0 - 180 | 965 | 100 |

4AR-L11/8TW-DIM-UNV-LM-OF-WH (25° tilt) Total Luminaire Output: 929 lumens; 14.6 Watts | Efficacy: 63.6 lm/W | 80 CRI; 4037K CCT

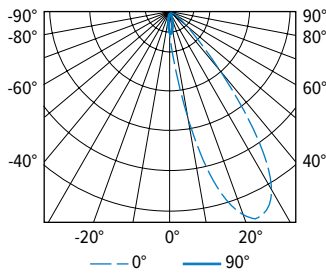

| VERTICAL ANGLE | HORIZONTAL ANGLE | | | | | ZONAL LUMENS |
|----------------|------------------|-----|-----|------|------|--------------|
| | 0° | 45° | 90° | 135° | 180° | |
| 0 | 284 | 284 | 284 | 284 | 284 | |
| 5 | 703 | 539 | 267 | 146 | 118 | 36 |
| 15 | 2286 | 990 | 164 | 65 | 56 | 169 |
| 25 | 2983 | 958 | 77 | 45 | 49 | 299 |
| 35 | 1957 | 423 | 40 | 45 | 55 | 247 |
| 45 | 548 | 105 | 29 | 46 | 59 | 106 |
| 55 | 98 | 31 | 22 | 38 | 49 | 41 |
| 65 | 24 | 13 | 13 | 25 | 33 | 21 |
| 75 | 9 | 5 | 6 | 11 | 16 | 9 |
| 85 | 1 | 0 | 0 | 0 | 1 | 1 |
| 90 | 0 | 0 | 0 | 0 | 0 | |

| LUMEN SUMMARY | ZONE | LUMENS | % FIXTURE |
|---------------|---------|--------|-----------|
| | 0 - 40 | 751 | 81 |
| | 0 - 60 | 898 | 97 |
| | 0 - 90 | 929 | 100 |
| | 0 - 180 | 929 | 100 |

4AR-L11/8TW-DIM-UNV-AM-OF-WH (25° tilt) Total Luminaire Output: 780 lumens; 14.6 Watts | Efficacy: 53.4 lm/W | 80 CRI; 4037K CCT

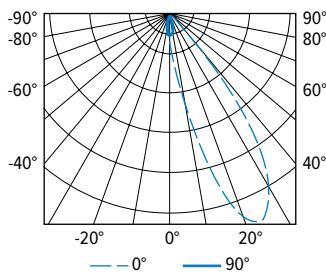

| VERTICAL ANGLE | HORIZONTAL ANGLE | | | | | ZONAL LUMENS |
|----------------|------------------|-----|-----|------|------|--------------|
| | 0° | 45° | 90° | 135° | 180° | |
| 0 | 253 | 253 | 253 | 253 | 253 | |
| 5 | 651 | 451 | 243 | 128 | 92 | 32 |
| 15 | 2198 | 919 | 141 | 43 | 29 | 157 |
| 25 | 3001 | 830 | 53 | 21 | 18 | 279 |
| 35 | 1894 | 304 | 24 | 22 | 24 | 216 |
| 45 | 384 | 54 | 18 | 21 | 23 | 71 |
| 55 | 38 | 12 | 13 | 15 | 15 | 17 |
| 65 | 10 | 7 | 6 | 6 | 4 | 6 |
| 75 | 3 | 2 | 0 | 0 | 1 | 1 |
| 85 | 0 | 0 | 0 | 0 | 0 | 0 |
| 90 | 0 | 0 | 0 | 0 | 0 | |

| LUMEN SUMMARY | ZONE | LUMENS | % FIXTURE |
|---------------|---------|--------|-----------|
| | 0 - 40 | 684 | 88 |
| | 0 - 60 | 772 | 99 |
| | 0 - 90 | 780 | 100 |
| | 0 - 180 | 780 | 100 |

TRIM TYPE DETAILS

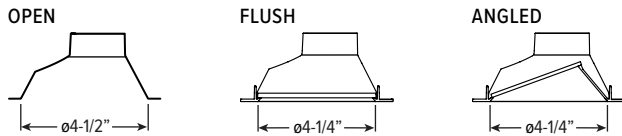

FLANGE TYPE DETAILS

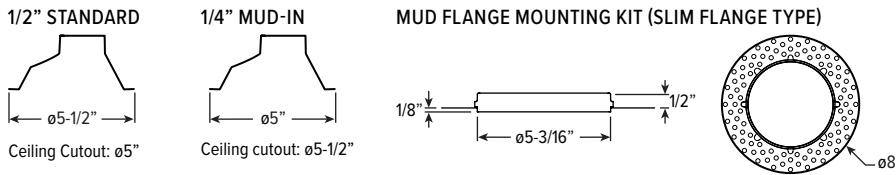

REFLECTOR FINISH DETAILS



4AR tunable **WHITE** 4.5" Adjustable Downlight – Round

MOUNTING TYPE DETAILS

NEW CONSTRUCTION

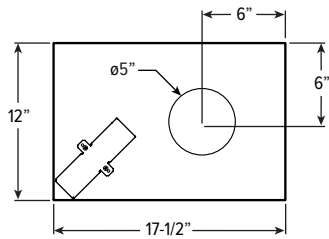

IC-RATED

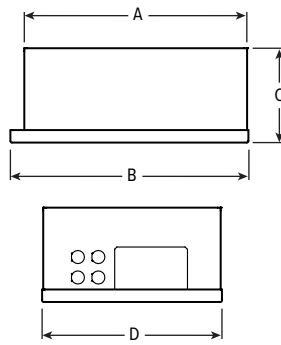

REMODEL

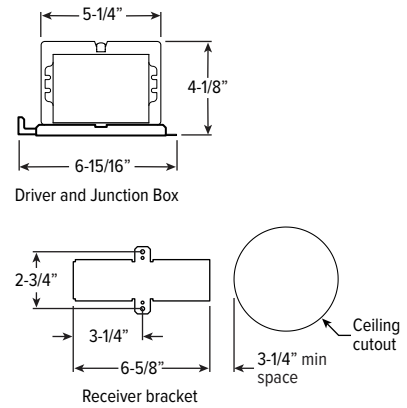

| LUMENS | LENGTH | | | |
|-----------|----------|-----|--------|---------|
| | A | B | C | D |
| L11 - L16 | 15-3/16" | 16" | 6-3/8" | 12-1/8" |

MOUNTING HARDWARE DETAILS

F1 2-Position fixed pan bracket, universal bar hanger included

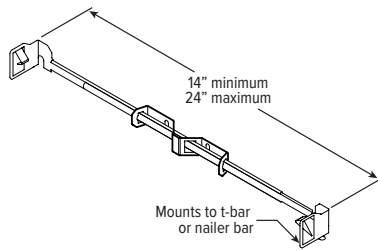

BA1 Adjustable butterfly pan bracket, bar hanger not included

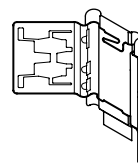

CA1 Adjustable caterpillar pan bracket, universal bar hanger included

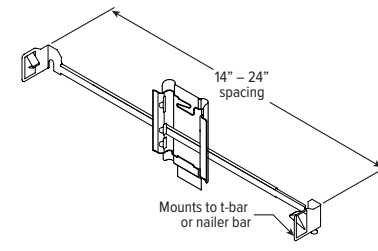

F2 2-Position fixed pan bracket, t-bar bar hanger included

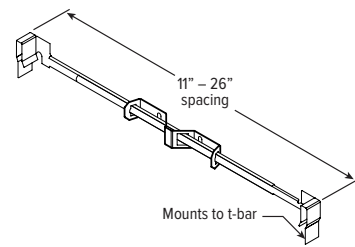

BA2 Adjustable butterfly pan bracket, heavy-duty universal bar hanger included

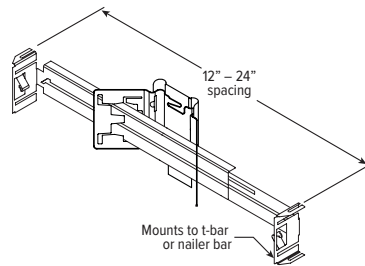

CA2 Adjustable caterpillar pan bracket, t-bar hanger included

