

4DR PoE | tunable WHITE 4.5" Downlight – Round

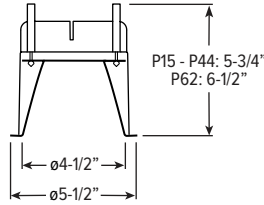

CATALOG #: _____

TYPE: _____

PROJECT: _____

NEW CONSTRUCTION AND REMODEL

FEATURES

TrimLock™

- Williams TrimLock reflector retention system eliminates trim sag
- Williams turn-key Power over Ethernet (PoE) solution provides plug-and-play networked lighting and control.

SYSTEM REQUIREMENTS

- Lighting system (site software)
- Gateway or alternate server (runs software)
- PoE switches or Ethernet switches and mid-span power injectors
- See hew.com/poe for details

SPECIFICATIONS

- HOUSING** – Die-cast aluminum trim housing with forged aluminum heat sink. Galvanized steel splice compartment with driver mounting plate/enclosure. Swing-out mounting arms adjust for ceiling thickness from 1/2" - 1-7/16".
- TRIMLOCK** – Innovative TrimLock reflector retention system ensures the trim remains flush with the ceiling plane.
- OPEN REFLECTOR** – Low-iridescent anodized aluminum. Clear semi-specular finish standard.
- LENSED TRIM** – Die-cast aluminum frame with micro-prismatic, tempered glass lens.
- ELECTRICAL** – High-performance Class 2 LED array. Modular quick-connect plug for easy field-connection of LED light assembly to driver. Reported L70>50,000 hours. Low-voltage DC fixture, to be fed by Class 2 power supply. Tunable White products use LEDs of multiple CCTs and may produce a perceptibly different shade of white from single-CCT products at the same CCT. All CCTs are within 3 MacAdam ellipses.
- MOUNTING** – Recessed. 20 ga. galvanized steel mounting pan for new construction or IC-rated enclosure. Remodel kit option includes receiver bracket hardware.
- LISTINGS** –
 - cCSAus conforms to UL STD 1598; Certified to CAN/CSA STD C22.2 No. 250.0 for damp locations. LED light assembly conforms to UL 2108 for remote installation.
 - Suitable for wet location under covered ceiling when specified with WET/CC option.
 - IC-rated for direct contact with insulation when specified with I Mounting Type.
 - City of Chicago Environmental Air approved when specified with CP option.
 - Complies with ASTM-E283 when specified with ATH option.
 - RoHS compliant.
- WARRANTY** – 5-year limited warranty, see hew.com/warranty.

ORDERING EXAMPLE:⁽¹⁾ 4DR - TL - P28/835 - OPTIONS - POE N - OW - OF - CS - TRIM OPTIONS - N - F1
 HOUSING TRIM MOUNT.

HOUSING

SERIES	LUMENS ⁽²⁾	CRI	CCT	OPTIONS	ACCESSORIES	CONTROL ⁽³⁾
4DR - TL	P15 1,500lm	8 80	27 2700K	SCA__ Sloped ceiling adapter ⁽⁵⁾	See hew.com/poe for compatible sensors & switches	POE N Power over Ethernet network node
TrimLock	P28 2,800lm	9 90	30 3000K	ATH Airtight construction ⁽⁶⁾		POE D Power over Ethernet device node
	P44 4,400lm		35 3500K	CP Chicago plenum (CCEA) ⁽⁷⁾		
	P62 6,200lm ⁽⁴⁾		40 4000K	F Fuse kit		
			TW Tunable white (80 CRI, 2700K–5000K)	TC Adjustable mounting arms for 1-1/2" – 2-1/4" thick ceilings		

TRIM

TRIM TYPE	DISTRIBUTION ⁽⁸⁾	FLANGE TYPE	REFLECTOR FINISH	TRIM OPTIONS
O Open reflector	W Wide	OF 1/2" standard flange	Open trim types	MWT Textured white trim flange ⁽¹⁵⁾
L Flush lens	65° Open	SF 1/4" mud-in flange ⁽¹⁴⁾	CS Clear semi-specular anodize	MB Regressed lens trim with texture black splay and white flange ⁽¹⁶⁾
R Regressed lens	50° Flush		SG Satin-glow anodize	IP IP65 rated trim ⁽¹⁷⁾
A Angled lens ⁽⁹⁾	50° Regressed		GD Gold anodize	AD Diffuse acrylic lens ⁽¹⁸⁾
S Non-conductive flush lens for shower applications ⁽¹⁰⁾	M Medium ⁽¹¹⁾		CG Champagne gold anodize	WET/CC Wet location, covered ceiling listed ⁽¹⁹⁾
	45° Open		PW Pewter anodize	
	35° Flush		SPC Clear specular anodize	
	30° Regressed		RG Rose gold anodize	
	N Narrow ⁽¹²⁾		WH White texture powder coat	
	10° Open		BL Black texture powder coat	
	25° Flush		Lens trim types	
	25° Regressed		WH White texture powder coat	
	WW Wall wash ⁽¹³⁾		BL Black texture powder coat	

MOUNTING

MOUNTING TYPE ⁽²⁰⁾	MOUNTING HARDWARE ⁽²¹⁾
N Open pan for new construction	F1 2-Position fixed pan bracket, universal bar hanger included
I IC-rated enclosure for new construction ⁽²²⁾	F2 2-Position fixed pan bracket, t-bar bar hanger included
R Remodel kit ⁽²³⁾	BA1 Adjustable butterfly pan bracket, bar hanger not included ⁽²⁴⁾
	BA2 Adjustable butterfly pan bracket, heavy-duty universal bar hanger included ⁽²⁵⁾
	CA1 Adjustable caterpillar pan bracket, universal bar hanger included
	CA2 Adjustable caterpillar pan bracket, t-bar hanger included

NOTES

- Housing, trim, and mounting ship separately.
- Static white lumen output based on O trim type, W distribution and CS finish, 3500K/80CRI. Actual lumens may vary +/-5%, see page 2 for FIXTURE PERFORMANCE DATA.
- For additional PoE info, see hew.com/poe
- Marked spacing required for P62 lumen package, consult factory. N Mounting Type only.
- 9" aperture, specify degrees of slope in 5° increments, 05°-30°, see page 4 for SLOPED CEILING ADAPTOR DETAILS. N Mounting Type only.
- I Mounting Type required.
- I Mounting Type required.
- Beam angle based on CS or WH reflector finish.
- Available with WW Distribution only.
- W Distribution, OF Flange Type and WH Reflector Finish only. Only available with AD diffuse acrylic lens, standard. IP and WET/CC options standard.
- Not available with lumen stops P44 and higher when specified with flush or regressed trim types.
- Not available with lumen stops P44 and higher when specified with flush or regressed trim types.
- O and A Trim Types only.
- For use with mud-in plaster construction only, supplied with mud flange installation kit, see page 4 for FLANGE TYPE DETAILS, not available with CP, ATH or IP options.
- O Trim Type and OF Flange Type only. Not available with WH Reflector Finish.
- R Trim Type only.
- L and R Trim Types only.
- L and R Trim Types only. Wide distribution only.
- Reduces lumen output, consult factory.
- Mounting hardware required (N and I only), ordered separately, see MOUNTING HARDWARE ordering info. See page 5 for MOUNTING TYPE DETAILS.
- Specify for N and I Mounting Types only. See page 5 for MOUNTING HARDWARE DETAILS.
- P15 lumen package max. P28 options available, consult factory.
- Also used in new construction sheetrock ceilings.
- N Mounting Type only.
- N Mounting Type only.



FIXTURE PERFORMANCE DATA

STANDARD

OPEN REFLECTOR TRIM TYPE

LED PACKAGE	DISTRIBUTION	DELIVERED LUMENS	WATTAGE	EFFICACY (lm/W)
P15	W	1537	12.3	125.5
	M	1480	12.3	120.8
	N	1426	12.3	116.4
P28	W	2822	25.0	112.9
	M	2719	25.0	108.8
	N	2619	25.0	104.8
P44	W	4408	37.5	117.5
	M	4234	37.5	112.9
	N	4039	37.5	107.7
P62	W	6151	50.0	123.0
	M	5822	50.0	116.4
	N	5612	50.0	112.2

TUNABLE WHITE

OPEN REFLECTOR TRIM TYPE

LED PACKAGE	DISTRIBUTION	DELIVERED LUMENS	WATTAGE	EFFICACY (lm/W)
P15	W	1311	12.3	107.0
	M	1263	12.3	103.1
	N	1216	12.3	99.3
P28	W	2649	25.0	105.9
	M	2544	25.0	101.8
	N	2427	25.0	97.1
P44	W	3963	37.5	105.7
	M	3751	37.5	100.0
	N	3615	37.5	96.4
P62	W	4597	43.5	105.7
	M	4351	43.5	100.0
	N	4194	43.5	96.4

FLUSH LENS TRIM TYPE

LED PACKAGE	DISTRIBUTION	DELIVERED LUMENS	WATTAGE	EFFICACY (lm/W)
P15	W	1196	12.3	97.6
	M	1356	12.3	110.7
	N	1365	12.3	111.4
P28	W	2196	25.0	87.8
	M	2491	25.0	99.6
	N	2507	25.0	100.3
P44	W	3430	37.5	91.5
	M	3890	37.5	103.7
	N	3916	37.5	104.4
P62	W	4786	50.0	95.7
	M	5428	50.0	108.6
	N	5464	50.0	109.3

FLUSH LENS TRIM TYPE

LED PACKAGE	DISTRIBUTION	DELIVERED LUMENS	WATTAGE	EFFICACY (lm/W)
P15	W	1020	12.3	83.3
	M	1157	12.3	94.4
	N	1164	12.3	95.1
P28	W	2061	25.0	82.4
	M	2337	25.0	93.5
	N	2353	25.0	94.1
P44	W	3083	37.5	82.2
	M	3497	37.5	93.3
	N	3520	37.5	93.9
P62	W	3576	43.5	82.2
	M	4056	43.5	93.3
	N	4083	43.5	93.9

REGRESSED LENS TRIM TYPE

LED PACKAGE	DISTRIBUTION	DELIVERED LUMENS	WATTAGE	EFFICACY (lm/W)
P15	W	1208	12.3	98.6
	M	1361	12.3	111.1
	N	1372	12.3	112.0
P28	W	2219	25.0	88.8
	M	2499	25.0	100.0
	N	2520	25.0	100.8
P44	W	3466	37.5	92.4
	M	3903	37.5	104.1
	N	3935	37.5	104.9
P62	W	4836	50.0	96.7
	M	5446	50.0	108.9
	N	5490	50.0	109.8

REGRESSED LENS TRIM TYPE

LED PACKAGE	DISTRIBUTION	DELIVERED LUMENS	WATTAGE	EFFICACY (lm/W)
P15	W	1031	12.3	84.1
	M	1161	12.3	94.7
	N	1170	12.3	95.5
P28	W	2083	25.0	83.3
	M	2345	25.0	93.8
	N	2364	25.0	94.6
P44	W	3116	37.5	83.1
	M	3508	37.5	93.6
	N	3537	37.5	94.3
P62	W	3614	43.5	83.1
	M	4070	43.5	93.6
	N	4103	43.5	94.3

MULTIPLIER TABLES

STANDARD		
	CCT	LUMENS
80 CRI	2700K	0.95
	3000K	0.96
	3500K	1.00
	4000K	1.01
90 CRI	2700K	0.74
	3000K	0.85
	3500K	0.90
	4000K	0.91

TUNABLE WHITE		
	CCT	LUMENS
80 CRI	2700K	0.83
	3000K	1.00
	3500K	0.99
	4000K	1.00
	5000K	0.98

OPEN REFLECTOR FINISH		
CATALOG NUMBER	REFLECTOR FINISH	CONVERSION FACTOR
CS	Clear semi-specular	1.00
SG	Satin-glow	0.92
GD	Gold	0.93
CG	Champagne Gold	0.96
PW	Pewter	0.86
SPC	Specular	1.02
RG	Rose Gold	0.88
WH	White, textured	0.89
BL	Black, textured	0.79

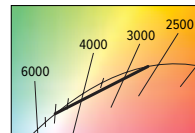

- Photometrics tested in accordance with IESNA LM-79. Results shown are based on 25°C ambient temperature.
- Standard results based on 3500K/80 CRI, actual lumens may vary +/-5%
- Tunable white results based on 4000K/80 CRI, actual lumens may vary +/-5%
- Use multiplier tables to calculate additional options.



4DR PoE | tunable WHITE 4.5" Downlight – Round

PHOTOMETRY

4DR-TL-P28/835-DIM-POE-OW-OF-CS Total Luminaire Output: 2822 lumens; 25.0 Watts | Efficacy: 112.9 lm/W | 82.7 CRI; 3604K CCT

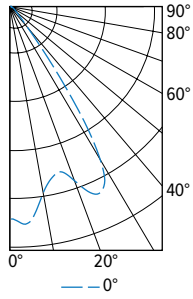

CANDLEPOWER DISTRIBUTION	VERTICAL ANGLE	HORIZONTAL ANGLE	ZONAL LUMENS
		0°	
	0	3065	
	5	3099	278
	15	2471	728
	25	2902	1265
	35	532	455
	45	81	66
	55	24	23
	65	6	7
	75	1	2
	85	0	0
	90	0	0

LUMEN SUMMARY	ZONE	LUMENS	% FIXTURE
	0 - 40	2725	97
	0 - 60	2814	100
	0 - 90	2822	100
	0-180	2822	100

4DR-TL-P28/835-DIM-POE-OM-OF-CS Total Luminaire Output: 2719 lumens; 25.0 Watts | Efficacy: 108.8 lm/W | 82.8 CRI; 3600K CCT

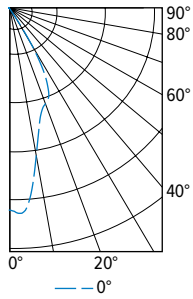

CANDLEPOWER DISTRIBUTION	VERTICAL ANGLE	HORIZONTAL ANGLE	ZONAL LUMENS
		0°	
	0	5502	
	5	5445	471
	15	3140	900
	25	2431	1051
	35	213	243
	45	49	39
	55	12	11
	65	3	3
	75	1	1
	85	0	0
	90	0	0

LUMEN SUMMARY	ZONE	LUMENS	% FIXTURE
	0-40	2665	98
	0-60	2715	100
	0-90	2719	100
	0-180	2719	100

4DR-TL-P28/835-DIM-POE-4DR-P20/835-DIM-UNV-ON-OF-CS Total Luminaire Output: 2619 lumens; 25.0 Watts | Efficacy: 104.8 lm/W | 82.8 CRI; 3587K CCT

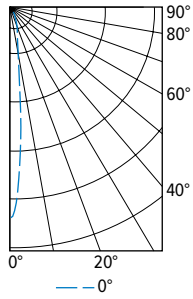

CANDLEPOWER DISTRIBUTION	VERTICAL ANGLE	HORIZONTAL ANGLE	ZONAL LUMENS
		0°	
	0	27850	
	5	13971	1016
	15	3100	868
	25	1192	583
	35	116	138
	45	13	10
	55	3	3
	65	1	1
	75	0	0
	85	0	0
	90	0	0

LUMEN SUMMARY	ZONE	LUMENS	% FIXTURE
	0-40	2604	99
	0-60	2618	100
	0-90	2619	100
	0-180	2619	100

4DR-TL-P28/835-DIM-POE-OWW-OF-CS Total Luminaire Output: 1598 lumens; 25.0 Watts | Efficacy: 63.9 lm/W | 82.6 CRI; 3596K CCT

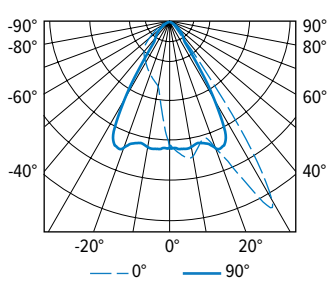

CANDLEPOWER DISTRIBUTION	VERTICAL ANGLE	HORIZONTAL ANGLE					ZONAL LUMENS
		0°	45°	90°	135°	180°	
	0	1463	1463	1463	1463	1463	
	5	1560	1493	1487	1137	1006	125
	15	1412	1402	1464	625	689	314
	25	2189	1629	1454	515	577	515
	35	613	364	315	430	480	281
	45	94	87	192	342	368	163
	55	42	39	99	201	204	106
	65	30	25	42	104	106	61
	75	10	7	16	51	48	28
	85	0	0	2	7	0	4
	90	0	0	0	0	0	0

LUMEN SUMMARY	ZONE	LUMENS	% FIXTURE
	0 - 40	1235	77
	0 - 60	1505	94
	0 - 90	1598	100
	0 - 180	1598	100



4DR PoE | tunable WHITE 4.5" Downlight – Round

4DR-TL-P28/835-DIM-POE-LM-OF-WH Total Luminaire Output: 2491 lumens; 25.0 Watts | Efficacy: 99.6 lm/W | 82.6 CRI; 3549K CCT

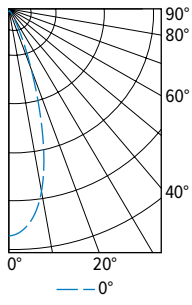

CANDLEPOWER DISTRIBUTION	VERTICAL ANGLE	HORIZONTAL ANGLE	ZONAL LUMENS
		0°	
	0	6445	
	5	6169	563
	15	3786	1013
	25	1024	494
	35	268	178
	45	122	96
	55	77	70
	65	48	47
	75	23	25
	85	5	6
	90	0	

LUMEN SUMMARY	ZONE	LUMENS	% FIXTURE
	0-40	2247	90
	0-60	2413	97
	0-90	2491	100
	0-180	2491	100

4DR-TL-P28/835-DIM-POE-RM-OF-WH Total Luminaire Output: 2499 lumens; 25.0 Watts | Efficacy: 100.0 lm/W | 82.7 CRI; 3546K CCT

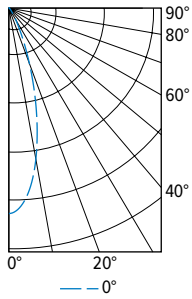

CANDLEPOWER DISTRIBUTION	VERTICAL ANGLE	HORIZONTAL ANGLE	ZONAL LUMENS
		0°	
	0	7205	
	5	6715	599
	15	3731	1013
	25	1094	523
	35	270	180
	45	104	83
	55	59	53
	65	31	31
	75	13	14
	85	3	4
	90	1	

LUMEN SUMMARY	ZONE	LUMENS	% FIXTURE
	0-40	2315	93
	0-60	2451	98
	0-90	2499	100
	0-180	2499	100

TRIMLOCK DETAILS

TWIST



PULL



RELEASE



SLOPED CEILING ADAPTOR DETAILS

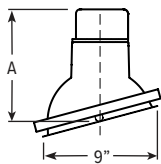

LUMENS	A (HEIGHT)						PLENUM HEIGHT
	5°	10°	15°	20°	25°	30°	
P15 - P44	8-13/16"	8-15/16"	9"	8-15/16"	8-7/8"	8-11/16"	9-1/4"
P62	9-9/16"	9-11/16"	9-11/16"	9-5/8"	9-1/2"	9-5/16"	10"

15° Shown

TRIM TYPE DETAILS

OPEN

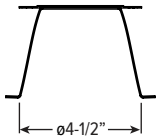

OPEN (WALL WASH)

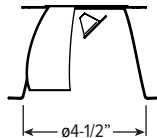

FLUSH

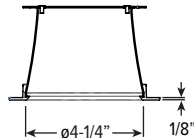

SHOWER

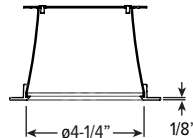

ANGLED

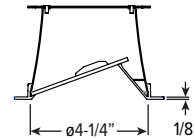

REGRESSED

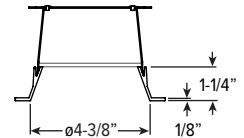

FLANGE TYPE DETAILS

1/2" STANDARD

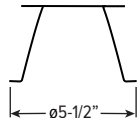

Ceiling Cutout: ø5"

1/4" MUD-IN

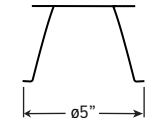

Ceiling cutout: ø5-1/2"

MUD FLANGE MOUNTING KIT (SLIM FLANGE TYPE)

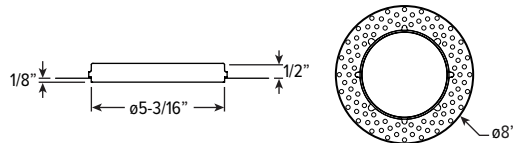

4DR PoE | tunable WHITE 4.5" Downlight – Round

REFLECTOR FINISH DETAILS

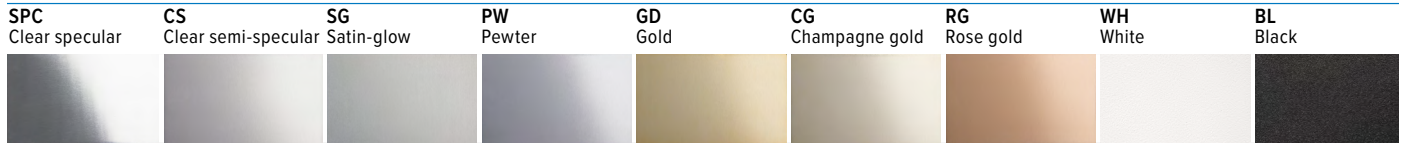

MOUNTING TYPE DETAILS

NEW CONSTRUCTION

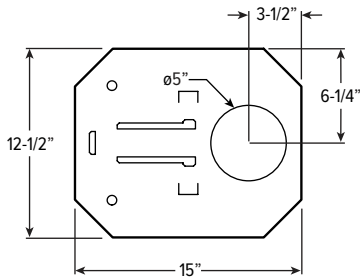

IC-RATED

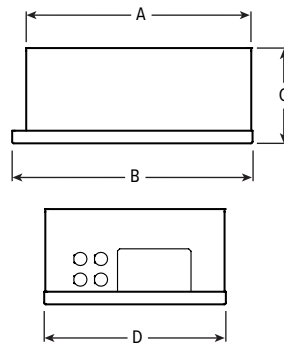

REMODEL

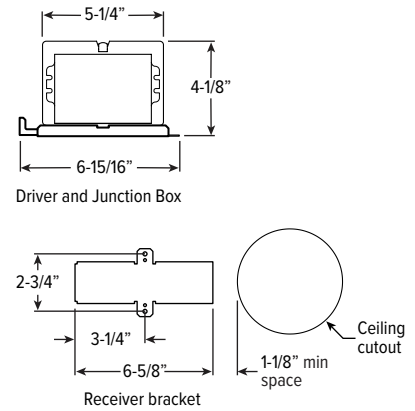

LUMENS	LENGTH			
	A	B	C	D
P15	15-3/16"	16"	6-3/8"	12-1/8"
L28	16-5/8"	17-1/2"	7-7/8"	14"

MOUNTING HARDWARE DETAILS

F1 2-Position fixed pan bracket, universal bar hanger included

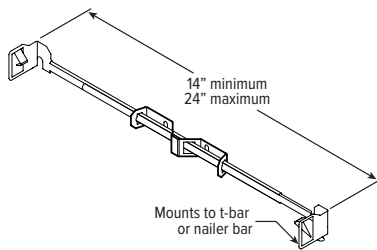

BA1 Adjustable butterfly pan bracket, bar hanger not included

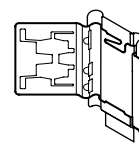

CA1 Adjustable caterpillar pan bracket, universal bar hanger included



F2 2-Position fixed pan bracket, t-bar bar hanger included

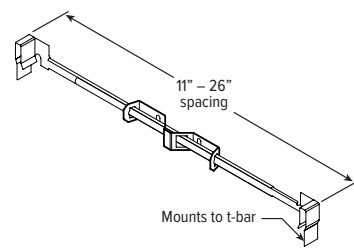

BA2 Adjustable butterfly pan bracket, heavy-duty universal bar hanger included

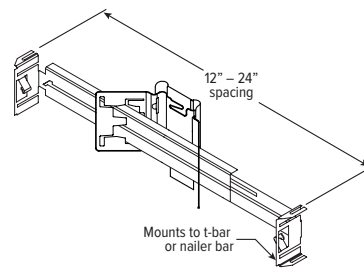

CA2 Adjustable caterpillar pan bracket, t-bar hanger included

