

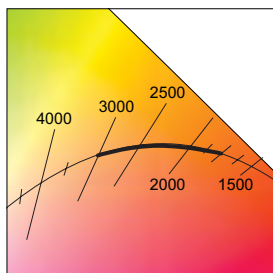

# 4PR dim to **WARM** 4.5" Shallow Plenum Downlight – Round

## FIXTURE PERFORMANCE DATA

LED PACKAGE	DISTRIBUTION	DELIVERED LUMENS	CCT AT 100% (FULL OUTPUT)	CCT AT 1% (FULL DIM)	WATTAGE	EFFICACY (lm/W)
L7	W	668	3000K	1800K	14.0	47.7
	M	777			14.0	55.5
	N	772			14.0	55.1
L12	W	1171			23.4	50.1
	M	1363			23.4	58.3
	N	1353			23.4	57.9
L20	W	1918			37.7	50.9
	M	2232			37.7	59.2
	N	2216			37.7	58.8



- Photometrics tested in accordance with IESNA LM-79. Results shown are based on 25°C ambient temperature.
- Wattage shown is based on 120V input.
- Results based on 3000K, 95 CRI, full output, actual lumens may vary +/-5%
- Use multiplier table to calculate additional options.

## PHOTOMETRY

4PR-TL-L20/9DW-DIM-UNV-LW-OF-WH Total Luminaire Output: 1918 lumens; 37.7 Watts | Efficacy: 50.9 lm/W | 95.0 CRI; 3000K CCT

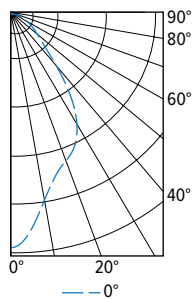

CANDLEPOWER DISTRIBUTION	VERTICAL ANGLE	HORIZONTAL ANGLE	ZONAL LUMENS
		0°	
	0	1535	
	5	1431	130
	15	1108	314
	25	970	443
	35	694	426
	45	319	255
	55	186	167
	65	109	109
	75	54	58
	85	14	17
	90	2	

LUMEN SUMMARY	ZONE	LUMENS	% FIXTURE
	0 - 40	1313	68
	0 - 60	1735	90
	0 - 90	1918	100
	0-180	1918	100

4PR-TL-L20/9DW-DIM-UNV-LM-OF-WH Total Luminaire Output: 2232 lumens; 37.7 Watts | Efficacy: 59.2 lm/W | 95.0 CRI; 3000K CCT

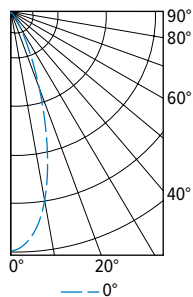

CANDLEPOWER DISTRIBUTION	VERTICAL ANGLE	HORIZONTAL ANGLE	ZONAL LUMENS
		0°	
	0	5244	
	5	4979	452
	15	3110	843
	25	1055	499
	35	316	207
	45	131	103
	55	68	61
	65	39	39
	75	20	21
	85	5	6
	90	1	

LUMEN SUMMARY	ZONE	LUMENS	% FIXTURE
	0 - 40	2001	90
	0 - 60	2166	97
	0 - 90	2232	100
	0-180	2232	100

4PR-TL-L20/9DW-DIM-UNV-LN-OF-WH Total Luminaire Output: 2216 lumens; 37.7 Watts | Efficacy: 58.8 lm/W | 95.0 CRI; 3000K CCT

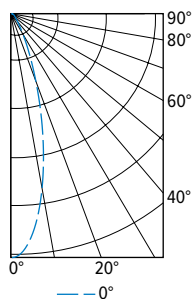

CANDLEPOWER DISTRIBUTION	VERTICAL ANGLE	HORIZONTAL ANGLE	ZONAL LUMENS
		0°	
	0	7437	
	5	6716	586
	15	3147	860
	25	841	404
	35	233	154
	45	110	86
	55	66	60
	65	40	39
	75	20	21
	85	5	6
	90	1	

LUMEN SUMMARY	ZONE	LUMENS	% FIXTURE
	0 - 40	2004	90
	0 - 60	2150	97
	0 - 90	2216	100
	0-180	2216	100



# 4PR dim to **WARM** 4.5" Shallow Plenum Downlight – Round

## TRIMLOCK DETAILS



## TRIM TYPE DETAILS

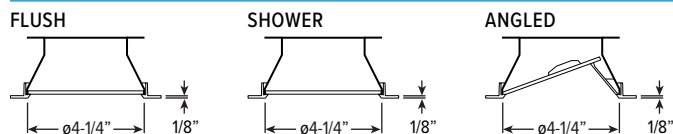

## FLANGE TYPE DETAILS

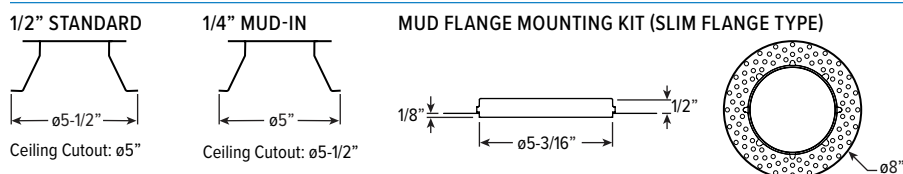

## REFLECTOR FINISH DETAILS

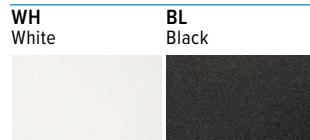

## MOUNTING TYPE DETAILS

### NEW CONSTRUCTION

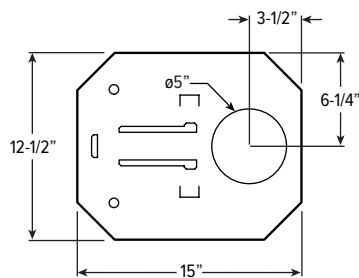

### IC-RATED

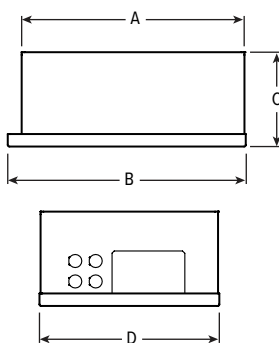

LUMENS	LENGTH			
	A	B	C	D
L7	15-1/16"	16"	4-1/2"	12-1/8"
L12	15-1/16"	16"	6-3/8"	12-1/8"

### REMODEL

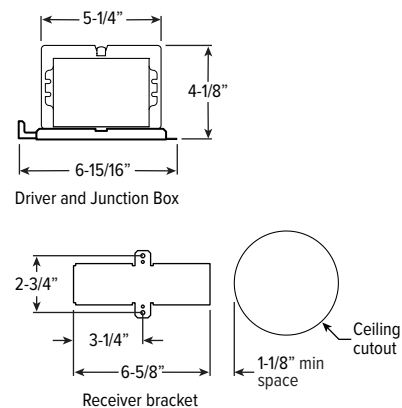

# 4PR dim to WARM 4.5" Shallow Plenum Downlight – Round

## MOUNTING HARDWARE DETAILS

**F1** 2-Position fixed pan bracket, universal bar hanger included

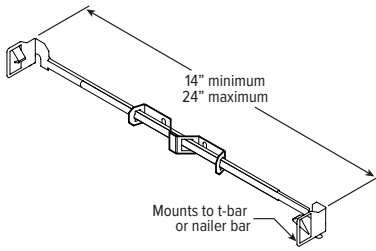

**BA1** Adjustable butterfly pan bracket, bar hanger not included

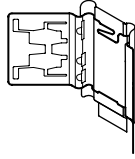

**CA1** Adjustable caterpillar pan bracket, universal bar hanger included

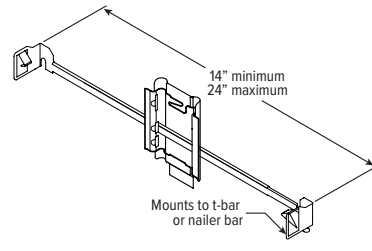

**F2** 2-Position fixed pan bracket, t-bar bar hanger included

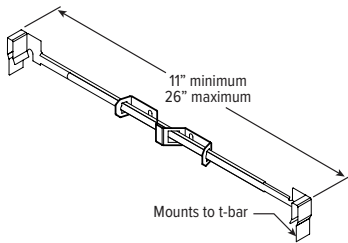

**BA2** Adjustable butterfly pan bracket, heavy-duty universal bar hanger included

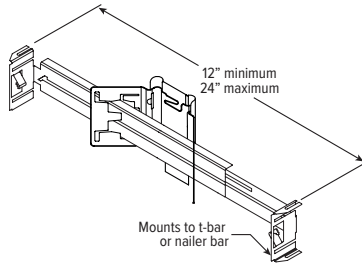

**CA2** Adjustable caterpillar pan bracket, t-bar hanger included

