

6AR tunable WHITE 6" Adjustable Downlight – Round

FIXTURE PERFORMANCE DATA

OPEN REFLECTOR TRIM TYPE

LED PACKAGE	DISTRIBUTION	DELIVERED LUMENS	WATTAGE	EFFICACY (lm/W)
L12	W	1180	14.6	80.8
	M	1228	14.6	84.1
L20	W	1985	24.0	82.7
	M	2027	24.0	84.5
L40	W	4013	46.7	85.9
	M	4097	46.7	87.7

FLUSH LENS TRIM TYPE

LED PACKAGE	DISTRIBUTION	DELIVERED LUMENS	WATTAGE	EFFICACY (lm/W)
L12	W	1065	14.6	72.9
	M	1141	14.6	78.2
	N	1133	14.6	77.6
L20	W	1771	24.0	73.8
	M	1877	24.0	78.2
	N	1793	24.0	74.7
L40	W	3581	46.7	76.7
	M	3795	46.7	81.3
	N	3625	46.7	77.6

ANGLED LENS TRIM TYPE

LED PACKAGE	DISTRIBUTION	DELIVERED LUMENS	WATTAGE	EFFICACY (lm/W)
L12	W	887	14.6	60.8
	M	1058	14.6	72.5
	N	1080	14.6	74.0
L20	W	1475	24.0	61.5
	M	1728	24.0	72.0
	N	1693	24.0	70.5
L40	W	2981	46.7	63.8
	M	3493	46.7	74.8
	N	3422	46.7	73.3

MULTIPLIER TABLE

COLOR TEMPERATURE		
CCT	LUMENS	WATTS
2700K	0.83	1.03
3000K	1.00	1.00
3500K	0.99	0.99
4000K	1.00	1.00
5000K	0.98	1.03

OPEN REFLECTOR FINISH		
CATALOG NUMBER	REFLECTOR FINISH	CONVERSION FACTOR
CS	Clear semi-specular	1.00
WH	White, textured	0.89
BL	Black, textured	0.79

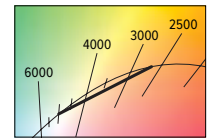

- Photometrics tested in accordance with IESNA LM-79. Results shown are based on 25°C ambient temperature.
- Wattage shown is based on 120V input.
- Results based on 4000K, 80 CRI, 0° tilt, actual lumens may vary +/-5%
- Use multiplier tables to calculate additional options.

PHOTOMETRY

6AR-L12/8TW-DIM-UNV-OW-OF-CS (25° tilt) Total Luminaire Output: 1104 lumens; 14.6 Watts | Efficacy: 75.6 lm/W | 80.0 CRI; 4037K CCT

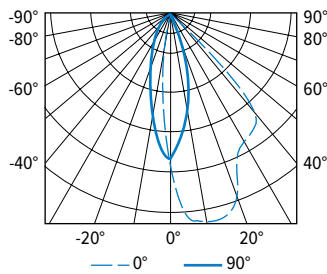

VERTICAL ANGLE	HORIZONTAL ANGLE					ZONAL LUMENS
	0°	45°	90°	135°	180°	
0	1459	1459	1459	1459	1459	
5	2038	1796	1292	900	726	121
15	2134	1593	740	248	174	263
25	1635	1424	303	68	52	306
35	1452	1068	61	15	11	281
45	949	119	6	3	3	126
55	11	1	0	0	1	7
65	0	0	0	0	0	0
75	0	0	0	0	0	0
85	0	0	0	0	0	0
90	0	0	0	0	0	0

LUMEN SUMMARY	ZONE	LUMENS	% FIXTURE
	0 - 40	971	88
	0 - 60	1104	100
	0 - 90	1104	100
	0 - 180	1104	100

6AR-L12/8TW-DIM-UNV-OM-OF-CS (25° tilt) Total Luminaire Output: 1093 lumens; 14.6 Watts | Efficacy: 74.9 lm/W | 80.0 CRI; 4037K CCT

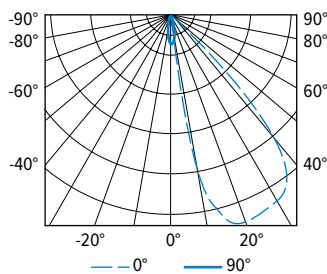

VERTICAL ANGLE	HORIZONTAL ANGLE					ZONAL LUMENS
	0°	45°	90°	135°	180°	
0	491	491	491	491	491	
5	1190	816	415	244	199	58
15	3461	1340	207	88	74	239
25	3511	992	87	37	30	365
35	3221	362	33	7	4	325
45	685	81	3	0	0	98
55	20	0	0	0	0	6
65	0	0	0	0	0	0
75	0	0	0	0	0	0
85	0	0	0	0	0	0
90	0	0	0	0	0	0

LUMEN SUMMARY	ZONE	LUMENS	% FIXTURE
	0 - 40	988	91
	0 - 60	1093	100
	0 - 90	1093	100
	0 - 180	1093	100



6AR tunable WHITE 6" Adjustable Downlight – Round

6AR-L12/8TW-DIM-UNV-LM-OF-WH (25° tilt) Total Luminaire Output: 1050 lumens; 14.6 Watts | Efficacy: 71.9 lm/W | 80.0 CRI; 4037K CCT

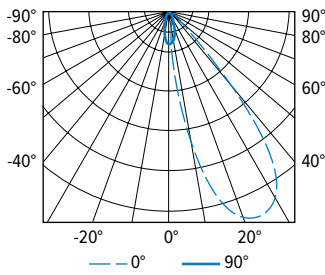

CANDLEPOWER DISTRIBUTION	VERTICAL ANGLE	HORIZONTAL ANGLE					ZONAL LUMENS
		0°	45°	90°	135°	180°	
	0	471	471	471	471	471	
	5	1229	887	439	259	198	58
	15	2789	1378	245	97	80	220
	25	3217	1088	114	55	50	333
	35	2307	474	54	37	40	269
	45	667	124	27	31	37	110
	55	137	32	18	25	31	38
	65	30	12	11	16	21	16
	75	10	5	4	7	11	7
	85	0	0	0	0	0	0
	90	0	0	0	0	0	0

LUMEN SUMMARY	ZONE	LUMENS	% FIXTURE
	0 - 40	879	84
	0 - 60	1027	98
	0 - 90	1050	100
	0 - 180	1050	100

6AR-L12/8TW-DIM-UNV-LN-OF-WH (25° tilt) Total Luminaire Output: 1130 lumens; 14.6 Watts | Efficacy: 77.4 lm/W | 80.0 CRI; 4037K CCT

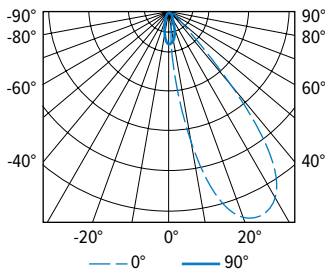

CANDLEPOWER DISTRIBUTION	VERTICAL ANGLE	HORIZONTAL ANGLE					ZONAL LUMENS
		0°	45°	90°	135°	180°	
	0	352	352	352	352	352	
	5	878	643	306	158	132	43
	15	3259	1081	150	54	47	210
	25	5109	881	62	30	28	393
	35	3603	357	30	20	18	326
	45	1054	87	16	10	11	128
	55	154	16	7	5	7	27
	65	13	3	1	1	2	4
	75	2	0	0	0	0	0
	85	0	0	0	0	0	0
	90	0	0	0	0	0	0

LUMEN SUMMARY	ZONE	LUMENS	% FIXTURE
	0 - 40	971	86
	0 - 60	1126	99
	0 - 90	1130	100
	0 - 180	1130	100

6AR-L12/8TW-DIM-UNV-AM-OF-WH (25° tilt) Total Luminaire Output: 997 lumens; 14.6 Watts | Efficacy: 68.3 lm/W | 80.0 CRI; 4037K CCT

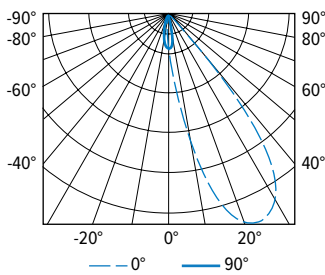

CANDLEPOWER DISTRIBUTION	VERTICAL ANGLE	HORIZONTAL ANGLE					ZONAL LUMENS
		0°	45°	90°	135°	180°	
	0	460	460	460	460	460	
	5	1028	776	415	247	199	53
	15	2652	1266	227	86	65	206
	25	3179	1018	98	39	31	322
	35	2517	428	41	20	20	275
	45	760	111	18	14	17	113
	55	75	16	10	10	12	22
	65	8	4	4	6	7	5
	75	3	1	0	1	2	1
	85	0	0	0	0	0	0
	90	0	0	0	0	0	0

LUMEN SUMMARY	ZONE	LUMENS	% FIXTURE
	0 - 40	856	86
	0 - 60	991	99
	0 - 90	997	100
	0 - 180	997	100

TRIM TYPE DETAILS

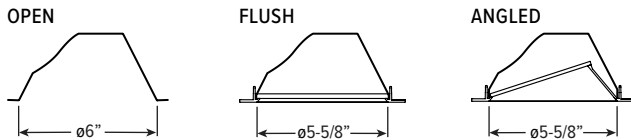

FLANGE TYPE DETAILS

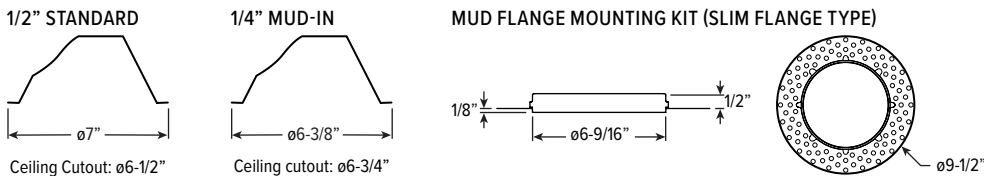

6AR tunable **WHITE** 6" Adjustable Downlight – Round

REFLECTOR FINISH DETAILS

CS
Clear semi-specular White

WH
White

BL
Black

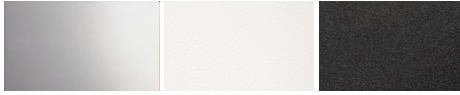

MOUNTING TYPE DETAILS

NEW CONSTRUCTION

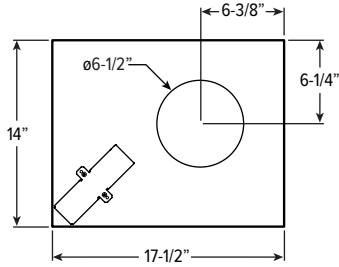

IC-RATED

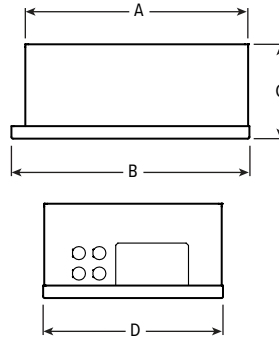

REMODEL

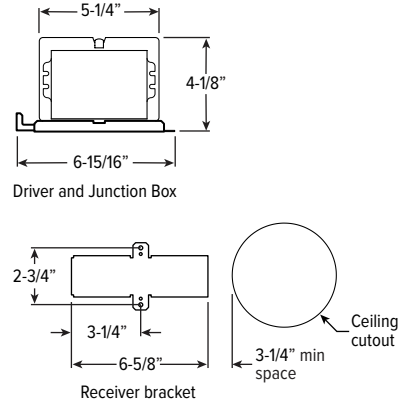

LUMENS	LENGTH			
	A	B	C	D
L12	15-3/16"	16"	6-3/8"	12-1/8"
L20	16-5/8"	17-1/2"	7-7/8"	14"

MOUNTING HARDWARE DETAILS

F1 2-Position fixed pan bracket, universal bar hanger included

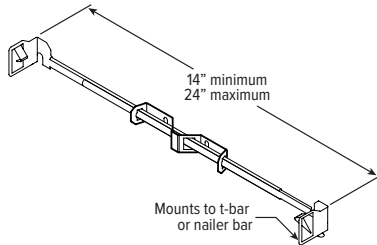

BA1 Adjustable butterfly pan bracket, bar hanger not included

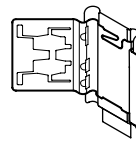

CA1 Adjustable caterpillar pan bracket, universal bar hanger included

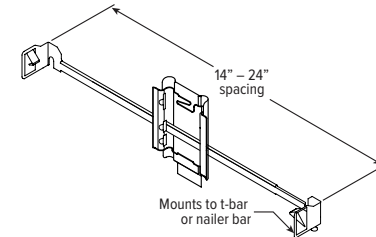

F2 2-Position fixed pan bracket, t-bar bar hanger included

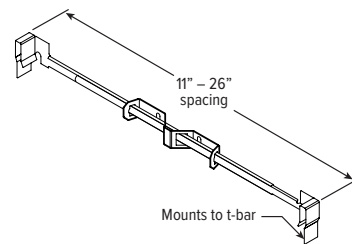

BA2 Adjustable butterfly pan bracket, heavy-duty universal bar hanger included

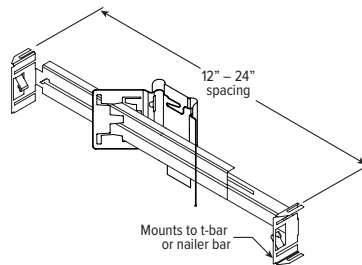

CA2 Adjustable caterpillar pan bracket, t-bar hanger included

