

6DR tunable WHITE 6" Downlight – Round

FIXTURE PERFORMANCE DATA

OPEN REFLECTOR TRIM TYPE

LED PACKAGE	DISTRIBUTION	DELIVERED LUMENS	WATTAGE	EFFICACY (lm/W)
L13	W	1319	14.6	90.3
	M	1317	14.6	90.2
	N	1345	14.6	92.1
L23	W	2357	24.0	98.0
	M	2285	24.0	95.0
	N	2187	24.0	90.9
L42	W	4304	44.9	96.0
	M	4173	44.9	93.0
	N	3994	44.9	89.0

FLUSH LENS TRIM TYPE

LED PACKAGE	DISTRIBUTION	DELIVERED LUMENS	WATTAGE	EFFICACY (lm/W)
L13	W	1135	14.6	78.0
	M	1220	14.6	83.6
	N	1231	14.6	84.5
L23	W	1964	24.0	81.7
	M	2117	24.0	88.0
	N	2129	24.0	88.5
L42	W	3596	44.9	80.2
	M	3876	44.9	86.4
	N	3900	44.9	86.9

REGRESSED LENS TRIM TYPE

LED PACKAGE	DISTRIBUTION	DELIVERED LUMENS	WATTAGE	EFFICACY (lm/W)
L13	W	1098	14.6	75.5
	M	1183	14.6	81.0
	N	1199	14.6	82.4
L23	W	1900	24.0	79.0
	M	2059	24.0	85.6
	N	2075	24.0	86.3
L42	W	3480	44.9	77.6
	M	3771	44.9	84.1
	N	3801	44.9	84.7

MULTIPLIER TABLE

COLOR TEMPERATURE		
CCT	LUMENS	WATTS
2700K	0.83	1.03
3000K	1.00	1.00
3500K	0.99	0.99
4000K	1.00	1.00
5000K	0.98	1.03

OPEN REFLECTOR FINISH		
CATALOG NUMBER	REFLECTOR FINISH	CONVERSION FACTOR
CS	Clear semi-specular	1.00
SG	Satin-glow	0.92
GD	Gold	0.93
CG	Champagne Gold	0.96
PW	Pewter	0.86
SPC	Specular	1.02
RG	Rose Gold	0.88
WH	White, textured	0.89
BL	Black, textured	0.79

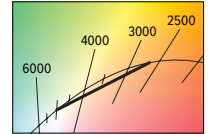

- Photometrics tested in accordance with IESNA LM-79. Results shown are based on 25°C ambient temperature.
- Wattage shown is based on 120V input.
- Results based on 4000K, 80 CRI, actual lumens may vary +/-5%
- Use multiplier tables to calculate additional options.

PHOTOMETRY

6DR-TL-L13/8TW-DIM-UNV-OW-OF-CS Total Luminaire Output: 1319 lumens; 14.6 Watts | Efficacy: 90.3 lm/W | 80.0 CRI; 4037K CCT

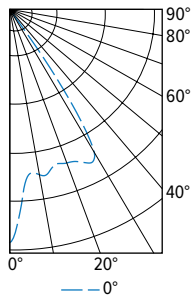

CANDLEPOWER DISTRIBUTION	VERTICAL ANGLE	HORIZONTAL ANGLE	ZONAL LUMENS
		0°	
	0	1606	
	5	1200	114
	15	1118	319
	25	1156	533
	35	403	294
	45	44	35
	55	17	16
	65	5	5
	75	1	1
	85	0	0
	90	0	

LUMEN SUMMARY	ZONE	LUMENS	% FIXTURE
	0 - 40	1261	96
	0 - 60	1312	100
	0 - 90	1319	100
	0 - 180	1319	100

6DR-TL-L13/8TW-DIM-UNV-OM-OF-CS Total Luminaire Output: 1317 lumens; 14.6 Watts | Efficacy: 90.2 lm/W | 80.0 CRI; 4037K CCT

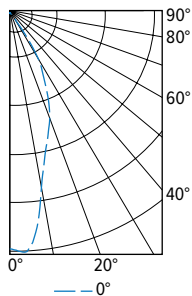

CANDLEPOWER DISTRIBUTION	VERTICAL ANGLE	HORIZONTAL ANGLE	ZONAL LUMENS
		0°	
	0	2665	
	5	2637	230
	15	1544	435
	25	938	430
	35	263	182
	45	31	27
	55	9	9
	65	3	3
	75	1	1
	85	0	0
	90	0	

LUMEN SUMMARY	ZONE	LUMENS	% FIXTURE
	0 - 40	1277	97
	0 - 60	1313	100
	0 - 90	1317	100
	0 - 180	1317	100



6DR tunable WHITE 6" Downlight – Round

6DR-TL-L13/8TW-DIM-UNV-ON-OF-CS Total Luminaire Output: 1345 lumens; 14.6 Watts | Efficacy: 92.1 lm/W | 80.0 CRI; 4037K CCT

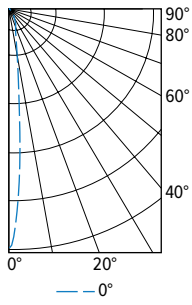

CANDLEPOWER DISTRIBUTION	VERTICAL ANGLE	HORIZONTAL ANGLE	ZONAL LUMENS
		0°	
	0	14608	
	5	6527	499
	15	1349	394
	25	678	322
	35	161	118
	45	9	7
	55	3	3
	65	1	1
	75	0	0
	85	0	0
	90	0	0

LUMEN SUMMARY	ZONE	LUMENS	% FIXTURE
	0 - 40	1334	99
	0 - 60	1344	100
	0 - 90	1345	100
	0 - 180	1345	100

6DR-TL-L13/8TW-DIM-UNV-OWW-OF-CS Total Luminaire Output: 670 lumens; 14.6 Watts | Efficacy: 45.9 lm/W | 80.0 CRI; 4037K CCT

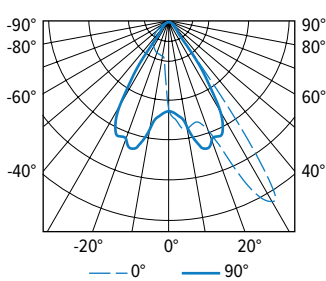

CANDLEPOWER DISTRIBUTION	VERTICAL ANGLE	HORIZONTAL ANGLE					ZONAL LUMENS
		0°	45°	90°	135°	180°	
	0	513	513	513	513	513	
	5	580	560	534	328	268	44
	15	592	579	749	183	194	124
	25	1031	614	698	159	182	226
	35	358	266	249	137	156	140
	45	28	24	58	110	123	52
	55	14	14	36	77	81	39
	65	11	10	21	46	48	27
	75	4	3	10	26	26	15
	85	0	0	2	7	5	4
	90	0	0	0	0	0	0

LUMEN SUMMARY	ZONE	LUMENS	% FIXTURE
	0 - 40	534	80
	0 - 60	625	93
	0 - 90	670	100
	0 - 180	670	100

6DR-TL-L13/8TW-DIM-UNV-LM-OF-WH Total Luminaire Output: 1220 lumens; 14.6 Watts | Efficacy: 83.6 lm/W | 80.0 CRI; 4037K CCT

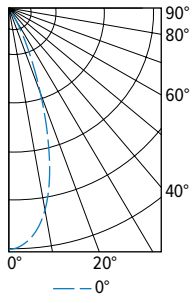

CANDLEPOWER DISTRIBUTION	VERTICAL ANGLE	HORIZONTAL ANGLE	ZONAL LUMENS
		0°	
	0	2880	
	5	2768	254
	15	1811	487
	25	562	268
	35	147	98
	45	59	47
	55	35	32
	65	21	21
	75	10	11
	85	2	3
	90	0	0

LUMEN SUMMARY	ZONE	LUMENS	% FIXTURE
	0 - 40	1107	91
	0 - 60	1185	97
	0 - 90	1220	100
	0 - 180	1220	100

6DR-TL-L13/8TW-DIM-UNV-RM-OF-WH Total Luminaire Output: 1183 lumens; 14.6 Watts | Efficacy: 81.0 lm/W | 80.0 CRI; 4037K CCT

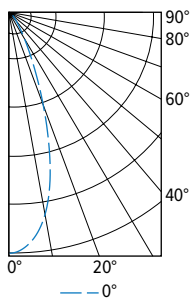

CANDLEPOWER DISTRIBUTION	VERTICAL ANGLE	HORIZONTAL ANGLE	ZONAL LUMENS
		0°	
	0	2864	
	5	2743	251
	15	1772	477
	25	562	267
	35	149	98
	45	50	41
	55	27	25
	65	15	15
	75	6	7
	85	2	2
	90	0	0

LUMEN SUMMARY	ZONE	LUMENS	% FIXTURE
	0 - 40	1094	92
	0 - 60	1159	98
	0 - 90	1183	100
	0 - 180	1183	100

TRIMLOCK DETAILS

TWIST



PULL



RELEASE



6DR tunable WHITE 6" Downlight – Round

SLOPED CEILING ADAPTOR DETAILS

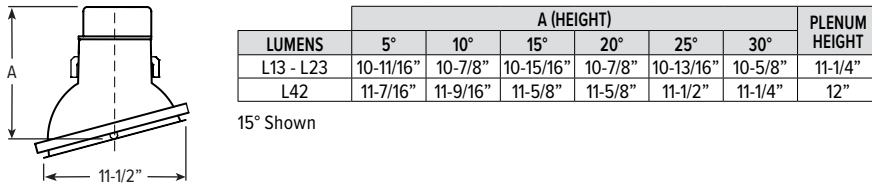

TRIM TYPE DETAILS

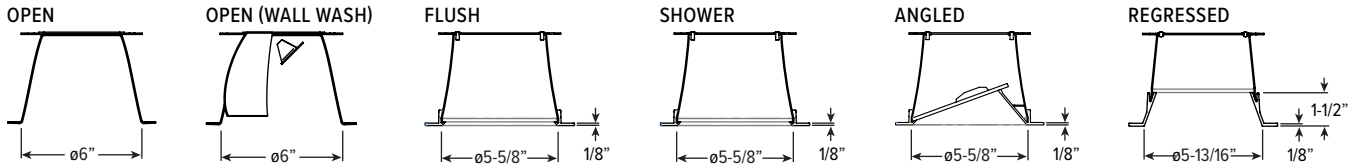

FLANGE TYPE DETAILS

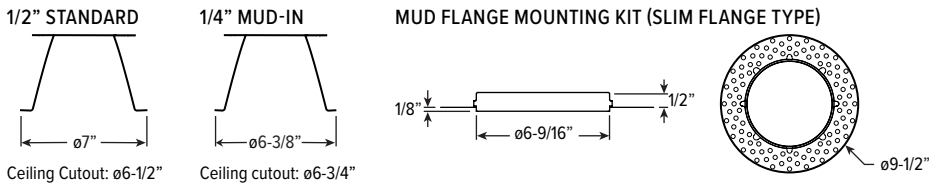

REFLECTOR FINISH DETAILS

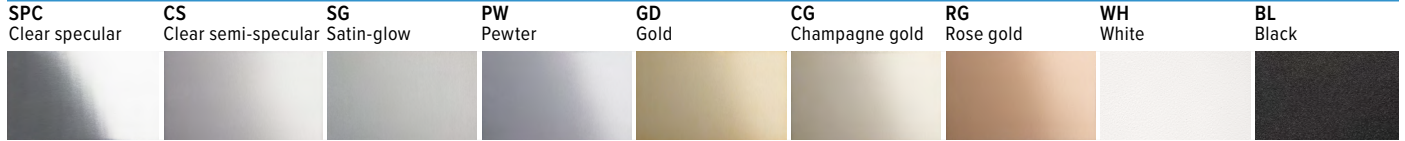

MOUNTING TYPE DETAILS

NEW CONSTRUCTION

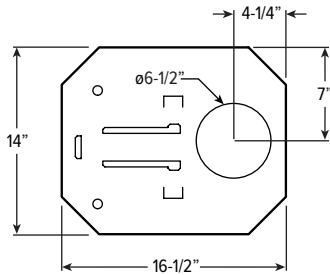

NEW CONSTRUCTION WITH EM/10W/ITS

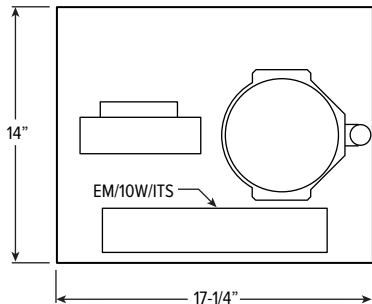

IC-RATED

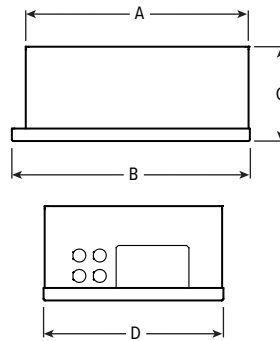

LUMENS	LENGTH			
	A	B	C	D
L13	15-3/16"	16"	6-3/8"	12-1/8"
L23	16-5/8"	17-1/2"	7-7/8"	14"

REMODEL

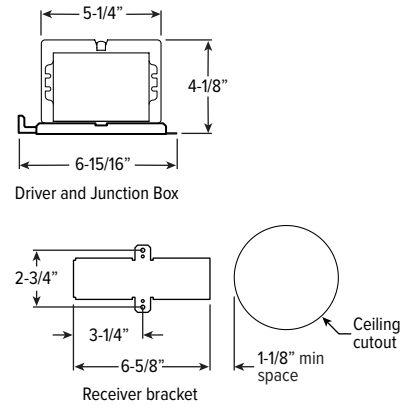

6DR tunable WHITE 6" Downlight – Round

MOUNTING HARDWARE DETAILS

F1 2-Position fixed pan bracket, universal bar hanger included

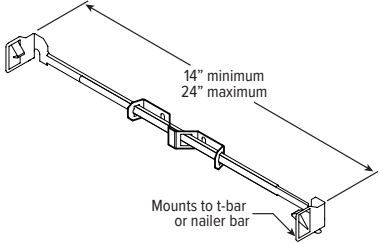

BA1 Adjustable butterfly pan bracket, bar hanger not included (N Mounting Type only)

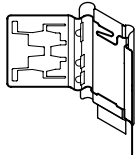

CA1 Adjustable caterpillar pan bracket, universal bar hanger included

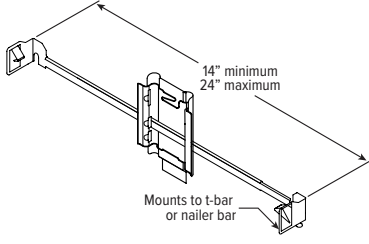

F2 2-Position fixed pan bracket, t-bar bar hanger included

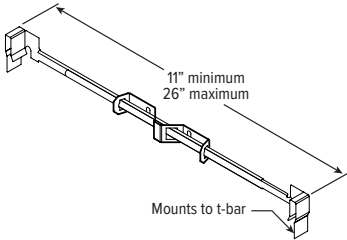

BA2 Adjustable butterfly pan bracket, heavy-duty universal bar hanger included (N Mounting Type only)

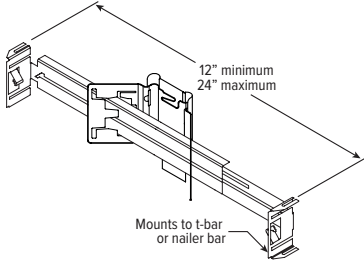

CA2 Adjustable caterpillar pan bracket, t-bar hanger included

