

FIXTURE PERFORMANCE DATA

STANDARD

OPEN REFLECTOR TRIM TYPE

LED PACKAGE	DISTRIBUTION	DELIVERED LUMENS	WATTAGE	EFFICACY (lm/W)
P16	W	1611	12.3	131.5
	M	1563	12.3	127.6
	N	1495	12.3	122.1
P29	W	2944	25.0	118.0
	M	2855	25.0	114.0
	N	2731	25.0	109.0
P46	W	4582	37.5	122.2
	M	4442	37.5	118.5
	N	4252	37.5	113.4
P62	W	6158	50.0	123.2
	M	5970	50.0	119.4
	N	5715	50.0	114.3

TUNABLE WHITE

OPEN REFLECTOR TRIM TYPE

LED PACKAGE	DISTRIBUTION	DELIVERED LUMENS	WATTAGE	EFFICACY (lm/W)
P16	W	1343	12.3	109.6
	M	1303	12.3	106.4
	N	1246	12.3	101.7
P29	W	2728	25.0	109.1
	M	2645	25.0	105.8
	N	2531	25.0	101.2
P46	W	4070	37.5	108.5
	M	3945	37.5	105.2
	N	3776	37.5	100.7
P62	W	4721	43.5	108.5
	M	4576	43.5	105.2
	N	4381	43.5	100.7

FLUSH LENS TRIM TYPE

LED PACKAGE	DISTRIBUTION	DELIVERED LUMENS	WATTAGE	EFFICACY (lm/W)
P16	W	1344	12.3	109.7
	M	1449	12.3	118.3
	N	1457	12.3	119.0
P29	W	2454	25.0	98.2
	M	2645	25.0	105.8
	N	2661	25.0	106.4
P46	W	3818	37.5	101.8
	M	4115	37.5	109.7
	N	4140	37.5	110.4
P62	W	5145	50.0	102.9
	M	5546	50.0	110.9
	N	5579	50.0	111.6

FLUSH LENS TRIM TYPE

LED PACKAGE	DISTRIBUTION	DELIVERED LUMENS	WATTAGE	EFFICACY (lm/W)
P16	W	1120	12.3	91.4
	M	1207	12.3	98.6
	N	1215	12.3	99.2
P29	W	2273	25.0	90.9
	M	2450	25.0	98.0
	N	2464	25.0	98.6
P46	W	3400	37.5	90.7
	M	3665	37.5	97.7
	N	3687	37.5	98.3
P62	W	3944	43.5	90.7
	M	4251	43.5	97.7
	N	4277	43.5	98.3

REGRESSED LENS TRIM TYPE

LED PACKAGE	DISTRIBUTION	DELIVERED LUMENS	WATTAGE	EFFICACY (lm/W)
P16	W	1301	12.3	106.2
	M	1409	12.3	115.0
	N	1420	12.3	115.9
P29	W	2375	25.0	95.0
	M	2573	25.0	103.9
	N	2593	25.0	103.7
P46	W	3695	37.5	98.5
	M	4003	37.5	106.8
	N	4035	37.5	107.6
P62	W	4980	50.0	99.6
	M	5396	50.0	107.9
	N	5438	50.0	108.8

REGRESSED LENS TRIM TYPE

LED PACKAGE	DISTRIBUTION	DELIVERED LUMENS	WATTAGE	EFFICACY (lm/W)
P16	W	1084	12.3	88.5
	M	1175	12.3	95.9
	N	1184	12.3	96.6
P29	W	2200	25.0	88.0
	M	2383	25.0	95.3
	N	2402	25.0	96.1
P46	W	3291	37.5	87.8
	M	3565	37.5	95.1
	N	3593	37.5	95.8
P62	W	3817	43.5	87.8
	M	4136	43.5	95.1
	N	4168	43.5	95.8

MULTIPLIER TABLES

STANDARD		
	CCT	LUMENS
80 CRI	2700K	0.95
	3000K	0.96
	3500K	1.00
	4000K	1.01
90 CRI	2700K	0.74
	3000K	0.85
	3500K	0.90
	4000K	0.91

TUNABLE WHITE		
	CCT	LUMENS
80 CRI	2700K	0.83
	3000K	1.00
	3500K	0.99
	4000K	1.00
	5000K	0.98

OPEN REFLECTOR FINISH		
CATALOG NUMBER	REFLECTOR FINISH	CONVERSION FACTOR
CS	Clear semi-specular	1.00
SG	Satin-glow	0.92
GD	Gold	0.93
CG	Champagne Gold	0.96
PW	Pewter	0.86
SPC	Specular	1.02
RG	Rose Gold	0.88
WH	White, textured	0.89
BL	Black, textured	0.79

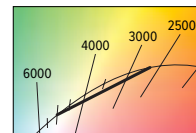

- Photometrics tested in accordance with IESNA LM-79. Results shown are based on 25°C ambient temperature.
- Standard results based on 3500K/80 CRI, actual lumens may vary +/-5%
- Tunable white results based on 4000K/80 CRI, actual lumens may vary +/-5%
- Use multiplier tables to calculate additional options.



6DR PoE | tunable WHITE 6" Downlight – Round

PHOTOMETRY

6DR-TL-P29/835-DIM-POE-OW-OF-CS Total Luminaire Output: 2944 lumens; 25.0 Watts | Efficacy: 117.8 lm/W | 82.7 CRI; 3598K CCT

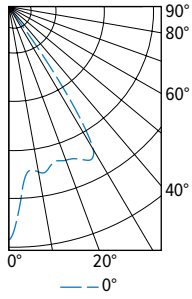

CANDLEPOWER DISTRIBUTION	VERTICAL ANGLE	HORIZONTAL ANGLE	ZONAL LUMENS
		0°	
	0	3583	
	5	2678	255
	15	2494	713
	25	2580	1190
	35	900	657
	45	97	78
	55	39	35
	65	11	11
	75	3	3
	85	1	1
	90	0	

LUMEN SUMMARY	ZONE	LUMENS	% FIXTURE
	0 - 40	2815	96
	0 - 60	2929	100
	0 - 90	2944	100
	0 - 180	2944	100

6DR-TL-P29/835-DIM-POE-OM-OF-CS Total Luminaire Output: 2855 lumens; 25.0 Watts | Efficacy: 114.2 lm/W | 82.7 CRI; 3579K CCT

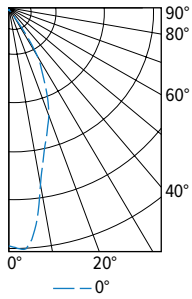

CANDLEPOWER DISTRIBUTION	VERTICAL ANGLE	HORIZONTAL ANGLE	ZONAL LUMENS
		0°	
	0	5778	
	5	5719	498
	15	3347	943
	25	2033	933
	35	569	395
	45	67	59
	55	20	19
	65	6	6
	75	2	2
	85	0	0
	90	0	

LUMEN SUMMARY	ZONE	LUMENS	% FIXTURE
	0 - 40	2769	97
	0 - 60	2847	100
	0 - 90	2855	100
	0 - 180	2855	100

6DR-TL-P29/835-DIM-POE-ON-OF-CS Total Luminaire Output: 2731 lumens; 25.0 Watts | Efficacy: 109.2 lm/W | 82.6 CRI; 3578K CCT

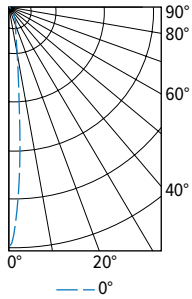

CANDLEPOWER DISTRIBUTION	VERTICAL ANGLE	HORIZONTAL ANGLE	ZONAL LUMENS
		0°	
	0	29655	
	5	13251	1013
	15	2739	801
	25	1376	655
	35	326	241
	45	18	14
	55	5	5
	65	1	2
	75	0	1
	85	0	0
	90	0	

LUMEN SUMMARY	ZONE	LUMENS	% FIXTURE
	0 - 40	2709	99
	0 - 60	2728	100
	0 - 90	2731	100
	0 - 180	2731	100

6DR-TL-P29/835-DIM-POE-OWW-OF-CS Total Luminaire Output: 1665 lumens; 25.0 Watts | Efficacy: 66.6 lm/W | 82.6 CRI; 3568K CCT

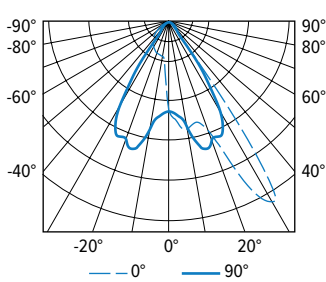

CANDLEPOWER DISTRIBUTION	VERTICAL ANGLE	HORIZONTAL ANGLE					ZONAL LUMENS
		0°	45°	90°	135°	180°	
	0	1275	1275	1275	1275	1275	
	5	1441	1391	1328	816	665	108
	15	1470	1439	1861	454	482	308
	25	2561	1526	1734	396	453	561
	35	889	660	619	340	387	348
	45	71	60	145	274	305	130
	55	35	34	89	191	201	98
	65	26	24	53	115	119	67
	75	11	8	25	64	64	36
	85	0	0	4	14	10	9
	90	0	0	0	0	0	

LUMEN SUMMARY	ZONE	LUMENS	% FIXTURE
	0 - 40	1326	80
	0 - 60	1553	93
	0 - 90	1665	100
	0 - 180	1665	100



6DR PoE | tunable WHITE 6" Downlight – Round

6DR-TL-P29/835-DIM-POE-LM-OF-WH Total Luminaire Output: 2646 lumens; 25.0 Watts | Efficacy: 105.8 lm/W | 82.6 CRI; 3549K CCT

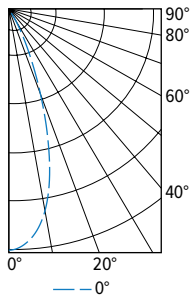

CANDLEPOWER DISTRIBUTION	VERTICAL ANGLE	HORIZONTAL ANGLE	ZONAL LUMENS
		0°	
	0	6246	
	5	6001	550
	15	3928	1056
	25	1220	582
	35	319	212
	45	128	102
	55	76	69
	65	46	45
	75	23	24
	85	5	6
	90	0	

LUMEN SUMMARY	ZONE	LUMENS	% FIXTURE
	0 - 40	2400	91
	0 - 60	2570	97
	0 - 90	2646	100
	0 - 180	2646	100

6DR-TL-P29/835-DIM-POE-RM-OF-WH Total Luminaire Output: 2573 lumens; 25.0 Watts | Efficacy: 102.9 lm/W | 82.7 CRI; 3546K CCT

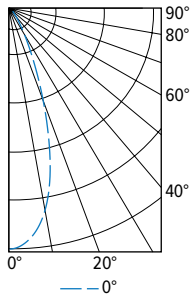

CANDLEPOWER DISTRIBUTION	VERTICAL ANGLE	HORIZONTAL ANGLE	ZONAL LUMENS
		0°	
	0	6227	
	5	5965	546
	15	3854	1037
	25	1222	581
	35	324	214
	45	110	88
	55	60	54
	65	33	33
	75	14	15
	85	4	4
	90	1	

LUMEN SUMMARY	ZONE	LUMENS	% FIXTURE
	0 - 40	2379	92
	0 - 60	2521	98
	0 - 90	2573	100
	0 - 180	2573	100

TRIMLOCK DETAILS

TWIST



PULL



RELEASE



SLOPED CEILING ADAPTOR DETAILS

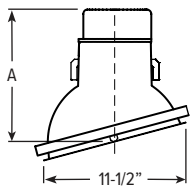

LUMENS	A (HEIGHT)						PLENUM HEIGHT
	5°	10°	15°	20°	25°	30°	
P16 - P46	10-11/16"	10-7/8"	10-15/16"	10-7/8"	10-13/16"	10-5/8"	11-1/4"
P62	11-7/16"	11-9/16"	11-5/8"	11-5/8"	11-1/2"	11-1/4"	12"

15° Shown

TRIM TYPE DETAILS

OPEN

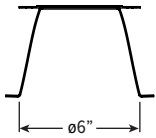

OPEN (WALL WASH)

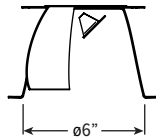

FLUSH

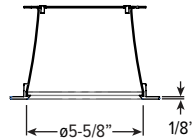

SHOWER

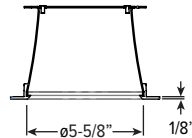

ANGLED

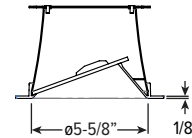

REGRESSED

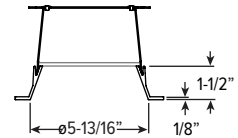

FLANGE TYPE DETAILS

1/2" STANDARD

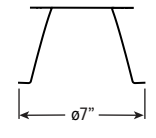

Ceiling Cutout: $\phi 6-1/2"$

1/4" MUD-IN

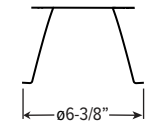

Ceiling cutout: $\phi 6-3/8"$

MUD FLANGE MOUNTING KIT (SLIM FLANGE TYPE)

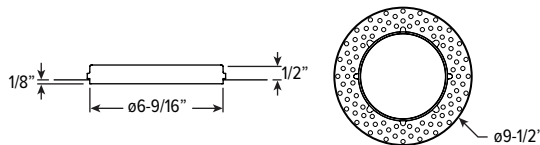

6DR PoE | tunable WHITE 6" Downlight – Round

REFLECTOR FINISH DETAILS

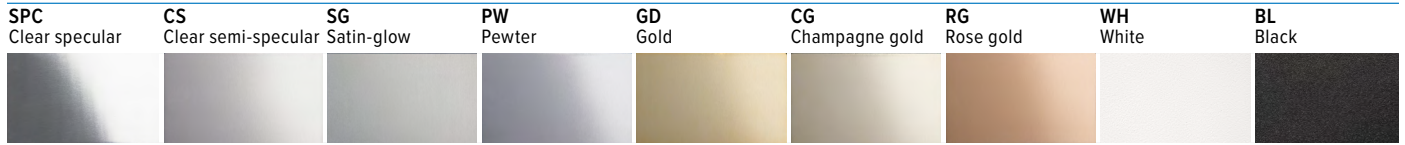

MOUNTING TYPE DETAILS

NEW CONSTRUCTION

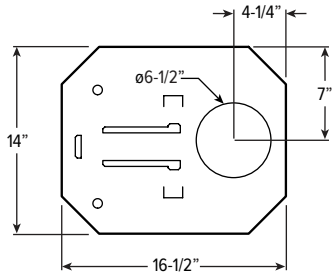

IC-RATED

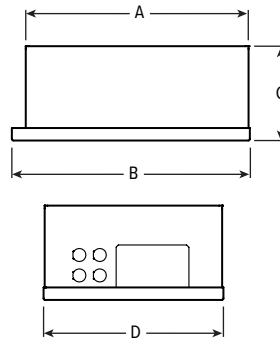

REMODEL

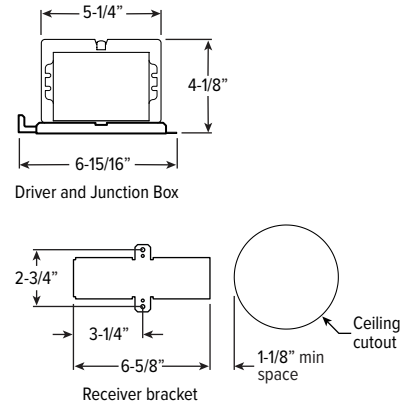

LUMENS	LENGTH			
	A	B	C	D
P16 - P29	15-3/16"	16"	6-3/8"	12-1/8"

MOUNTING HARDWARE DETAILS

F1 2-Position fixed pan bracket, universal bar hanger included

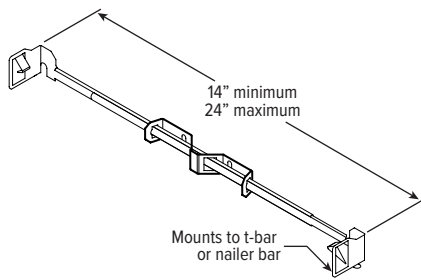

BA1 Adjustable butterfly pan bracket, bar hanger not included (N Mounting Type)

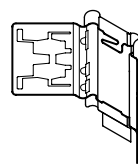

CA1 Adjustable caterpillar pan bracket, universal bar hanger included

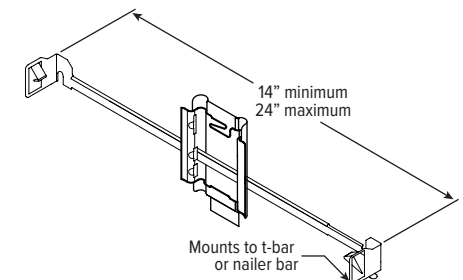

F2 2-Position fixed pan bracket, t-bar bar hanger included

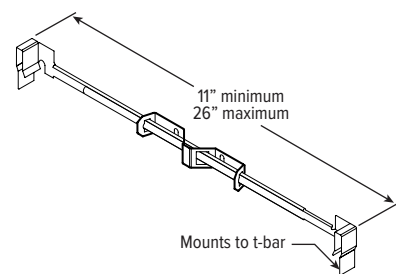

BA2 Adjustable butterfly pan bracket, heavy-duty universal bar hanger included (N Mounting Type)

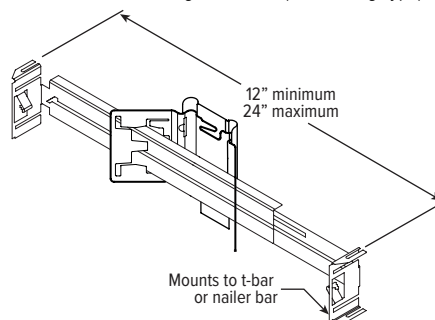

CA2 Adjustable caterpillar pan bracket, t-bar hanger included

