

6PR dim to WARM

6" Shallow Plenum Downlight – Round

FIXTURE PERFORMANCE DATA

LED PACKAGE	DISTRIBUTION	DELIVERED LUMENS	CCT AT 100% (FULL OUTPUT)	CCT AT 1% (FULL DIM)	WATTAGE	EFFICACY (lm/W)
L8	W	806	3000K	1800K	14.0	57.6
	M	817			14.0	58.4
	N	825			14.0	58.9
L14	W	1413			23.4	60.4
	M	1433			23.4	61.2
	N	1446			23.4	61.8
L23	W	2314			37.7	61.4
	M	2347			37.7	62.3
	N	2369			37.7	62.8

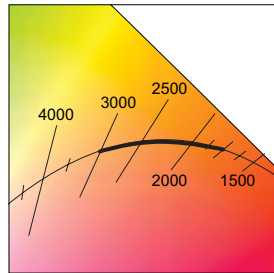

- Photometrics tested in accordance with IESNA LM-79. Results shown are based on 25°C ambient temperature.
- Wattage shown is based on 120V input.
- Results based on 3000K, 95 CRI, full output, actual lumens may vary +/-5%
- Use multiplier table to calculate additional options.

PHOTOMETRY

6PR-TL-L23/9DW-DIM-UNV-LW-OF-WH Total Luminaire Output: 2314 lumens; 37.7 Watts | Efficacy: 61.4 lm/W | 95.0 CRI; 3000K CCT

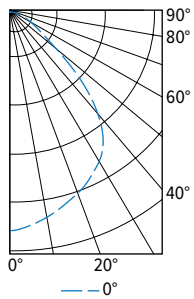

CANDLEPOWER DISTRIBUTION	VERTICAL ANGLE	HORIZONTAL ANGLE	ZONAL LUMENS
		0°	
	0	1225	
	5	1203	114
	15	1127	318
	25	1036	477
	35	901	557
	45	582	442
	55	233	218
	65	116	117
	75	53	57
	85	12	15
	90	1	

LUMEN SUMMARY	ZONE	LUMENS	% FIXTURE
	0 - 40	1466	63
	0 - 60	2126	92
	0 - 90	2314	100
	0 - 180	2314	100

6PR-TL-L23/9DW-DIM-UNV-LM-OF-WH Total Luminaire Output: 2347 lumens; 37.7 Watts | Efficacy: 62.3 lm/W | 95.0 CRI; 3000K CCT

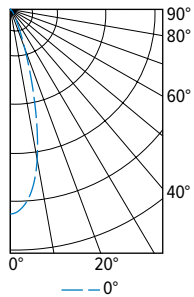

CANDLEPOWER DISTRIBUTION	VERTICAL ANGLE	HORIZONTAL ANGLE	ZONAL LUMENS
		0°	
	0	5398	
	5	5188	476
	15	3397	913
	25	1074	512
	35	319	209
	45	140	110
	55	73	66
	65	37	37
	75	18	19
	85	3	4
	90	0	

LUMEN SUMMARY	ZONE	LUMENS	% FIXTURE
	0 - 40	2110	90
	0 - 60	2286	97
	0 - 90	2347	100
	0 - 180	2347	100

6PR-TL-L23/9DW-DIM-UNV-LN-OF-WH Total Luminaire Output: 2369 lumens; 37.7 Watts | Efficacy: 62.8 lm/W | 95.0 CRI; 3000K CCT

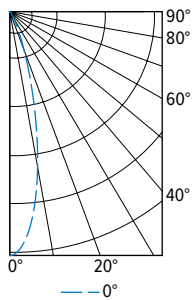

CANDLEPOWER DISTRIBUTION	VERTICAL ANGLE	HORIZONTAL ANGLE	ZONAL LUMENS
		0°	
	0	8749	
	5	7909	686
	15	3390	933
	25	808	392
	35	223	147
	45	112	88
	55	69	62
	65	38	38
	75	17	18
	85	3	4
	90	0	

LUMEN SUMMARY	ZONE	LUMENS	% FIXTURE
	0 - 40	2159	91
	0 - 60	2308	97
	0 - 90	2369	100
	0 - 180	2369	100



6PR dim to **WARM** 6" Shallow Plenum Downlight – Round

TRIMLOCK DETAILS



TRIM TYPE DETAILS

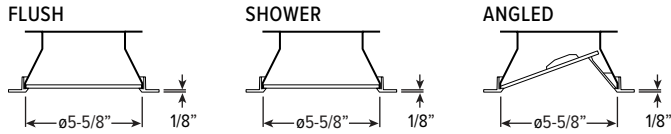

FLANGE TYPE DETAILS

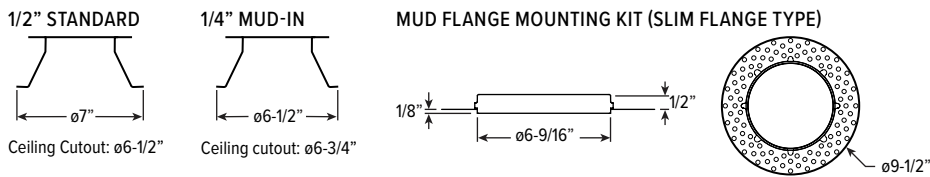

REFLECTOR FINISH DETAILS

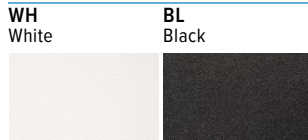

MOUNTING TYPE DETAILS

NEW CONSTRUCTION

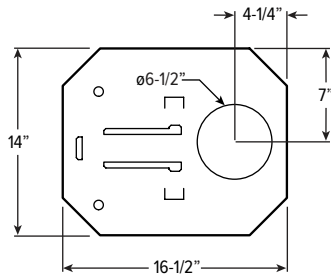

IC-RATED

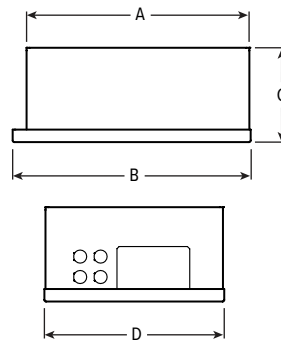

LUMENS	LENGTH			
	A	B	C	D
L8	15-1/16"	16"	4-1/2"	12-1/8"
L14	15-3/16"	16"	6-3/8"	12-1/8"

REMODEL

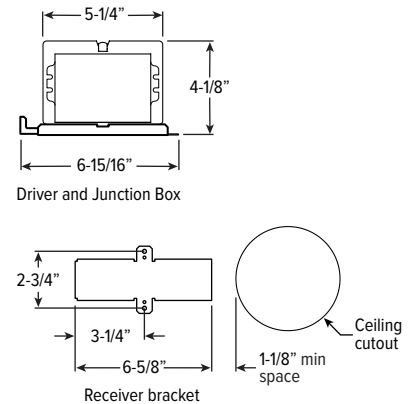

6PR dim to WARM

6" Shallow Plenum Downlight – Round

MOUNTING HARDWARE DETAILS

F1 2-Position fixed pan bracket, universal bar hanger included

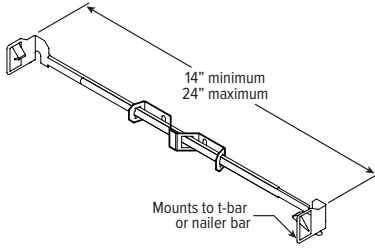

BA1 Adjustable butterfly pan bracket, bar hanger not included

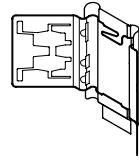

CA1 Adjustable caterpillar pan bracket, universal bar hanger included

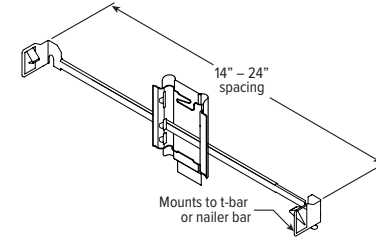

F2 2-Position fixed pan bracket, t-bar bar hanger included

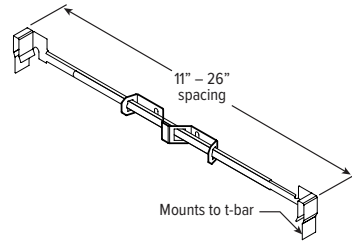

BA2 Adjustable butterfly pan bracket, heavy-duty universal bar hanger included

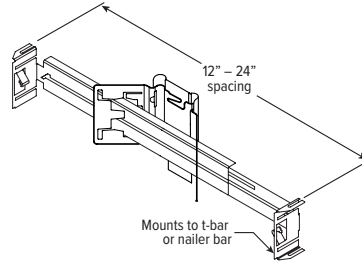

CA2 Adjustable caterpillar pan bracket, t-bar hanger included

