

M4PS dim to WARM

4.5" MRI Shallow Plenum Downlight – Square

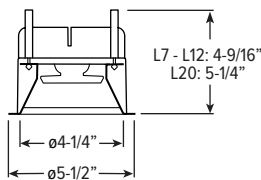

Pan Size: 12-1/16" x 16-1/4"

CATALOG #: _____

TYPE: _____

PROJECT: _____

FEATURES

- Dim to warm from 1800K to 3000K CCT, minimum 95 CRI
- Designed with non-ferrous materials for MRI imaging suites
- IP65-rated die-cast trim includes easy-to-clean flush lens
- Slim 5" depth for minimal plenum space applications
- Beam angles ranging from 30° narrow to 75° wide for tailored performance
- 4 inch aperture is unobtrusive in small scale spaces
- Square shape accentuates architectural styles
- Spring clip retention system eliminates trim sag
- Contemporary design provides glare-free illumination for a soft ceiling appearance
- Fully room-side accessible

SPECIFICATIONS

- HOUSING – Spun housing with forged aluminum heat sink. Aluminum splice compartment. Trim housing adjusts for ceiling thickness from 1/2" - 1-1/2".
- LENSED TRIM – Die-cast aluminum frame with micro-prismatic, tempered glass lens.
- ELECTRICAL – Five color, mid-power LED modules. On board thermal and optical feedback ensure color consistency of <math><2</math> step MacAdam ellipse (SDCM). In-line spectral capture and storage results in consistent CRI and CCT across all arrays. Reported L70>55,000 hours. Reported L90>55,000 hours. Estimated L70 = 200,000 hours.
- MOUNTING – Recessed. Aluminum mounting pan for new construction or IC-rated enclosure. Remote mounted driver enclosure required, ordered separately, must be located outside MRI room.
- LISTINGS –
 - cCSAus conforms to UL STD 1598; Certified to CAN/CSA STD C22.2 No. 250.0 for damp locations. LED light assembly conforms to UL 2108 for remote installation.
 - Suitable for wet location under covered ceiling when specified with WET/CC option.
 - IC-rated for direct contact with insulation when specified with I Mounting Type.
 - City of Chicago Environmental Air approved when specified with CP option.
 - Complies with ASTM-E283 when specified with ATH option.
 - RoHS compliant.
- WARRANTY – 5-year limited warranty, see hew.com/warranty.

ORDERING EXAMPLE:⁽¹⁾ **M4PS - L20/9DW - OPTIONS - LW - OF - WH - TRIM OPTIONS - N - F1M**

HOUSING
TRIM
MOUNT

HOUSING

SERIES	LUMENS ⁽²⁾	COLOR	OPTIONS
M4PS	L7 700lm	9DW Dim to warm (95 CRI, 1800K – 3000K)	ATH Airtight construction ⁽³⁾
	L12 1,200lm		CP Chicago plenum (CCEA) ⁽⁴⁾
	L20 2,000lm		

TRIM

TRIM TYPE	DISTRIBUTION ⁽⁵⁾	FLANGE TYPE	REFLECTOR FINISH	TRIM OPTIONS
L Flush lens	W 75° Wide	OF 1/2" standard flange SF 1/4" mud-in flange ⁽⁶⁾	WH White texture powder coat BL Black texture powder coat	IP IP65 rated trim
	M 35° Medium			AD Diffuse acrylic lens ⁽⁷⁾
	N 30° Narrow			WET/CC Wet location, covered ceiling listed

MOUNTING

MOUNTING TYPE ⁽⁸⁾	MOUNTING HARDWARE ⁽⁹⁾
N Open pan for new construction	F1M 2-Position fixed pan bracket, aluminum, universal bar hanger included
I IC-rated enclosure for new construction ⁽¹⁰⁾	BA1M Adjustable butterfly pan bracket, aluminum, bar hanger not included ⁽¹¹⁾
	CA1M Adjustable caterpillar pan bracket, aluminum, universal bar hanger included

REMOTE DRIVER ENCLOSURE (ORDERED SEPARATELY)⁽¹²⁾

ORDERING EXAMPLE: M4PS - RDB1 - L20 - OPTIONS - DIM - UNV

SERIES	DRIVER BOX	DRIVER QTY.	LUMENS	OPTIONS	CONTROL ⁽¹³⁾	VOLTAGE
M4PS	RDB Remote driver enclosure	1 7	L7 700lm	EM/12W 12-watt emergency battery ⁽¹⁴⁾	DIM Dimming driver (0-10V signal to control dimming and CCT)	UNV 120-277V 347 347V ⁽¹⁶⁾
		2 8	L12 1,200lm			
		3 9	L20 2,000lm			
		4 10	F Fuse kit			
		5 11	SDT Stepdown transformer ⁽¹⁵⁾			
		6 12	LUT Lutron Ecosystem enabled			

NOTES

- Housing, trim, and mounting ship separately.
- Lumen output based on full light output, W distribution and WH finish, 3000K/95CRI. Actual lumens may vary +/-5%, see page 2 for FIXTURE PERFORMANCE DATA.
- I Mounting Type required.
- I Mounting Type required.
- Beam angle based on WH reflector finish.
- For use with mud-in plaster construction only, supplied with mud flange installation kit, see page 3 for FLANGE TYPE DETAILS, not available with ATH, CP or IP options.
- Wide distribution only.
- Mounting hardware required, ordered separately, see MOUNTING HARDWARE ordering info. See page 3 for MOUNTING TYPE DETAILS.
- See page 3 for MOUNTING HARDWARE DETAILS.
- L12 lumen package max.
- N Mounting Type only.
- Required. Ordered as a separate catalog number, ships separately. See page 4 for REMOTE DRIVER ENCLOSURE DETAILS.
- All drivers dimmed by single control signal.
- Available with RDB1 only.
- May be required for 347V, see product builder at hew.com
- Not available with EM batteries.



M4PS dim to WARM

4.5" MRI Shallow Plenum Downlight – Square

FIXTURE PERFORMANCE DATA

LED PACKAGE	DISTRIBUTION	DELIVERED LUMENS	CCT AT 100% (FULL OUTPUT)	CCT AT 1% (FULL DIM)	WATTAGE	EFFICACY (lm/W)
L7	W	753	3000K	1800K	14.0	53.8
	M	780			14.0	55.7
	N	754			14.0	53.7
L12	W	1321			23.4	56.5
	M	1367			23.4	58.5
	N	1323			23.4	56.6
L20	W	1955			37.7	51.9
	M	2021			37.7	53.6
	N	1956			37.7	51.9

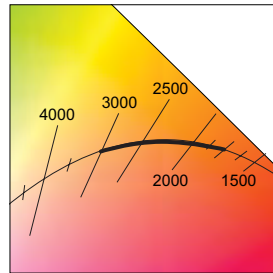

- Photometrics tested in accordance with IESNA LM-79. Results shown are based on 25°C ambient temperature.
- Wattage shown is based on 120V input.
- Results based on 3000K, 95 CRI, full output, actual lumens may vary +/-5%
- Use multiplier table to calculate additional options.

PHOTOMETRY

M4PS-L20/9DW-DIM-UNV-LW-OF-WH Total Luminaire Output: 1955 lumens; 37.7 Watts | Efficacy: 51.9 lm/W | 95.0 CRI; 3000K CCT

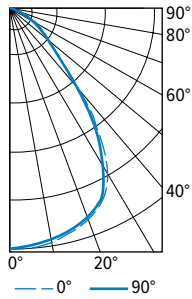

CANDLEPOWER DISTRIBUTION	VERTICAL ANGLE	HORIZONTAL ANGLE			ZONAL LUMENS
		0°	45°	90°	
	0	1100	1100	1100	
	5	1100	1094	1093	104
	15	1060	1055	1052	298
	25	991	994	981	452
	35	704	838	684	470
	45	317	488	306	305
	55	181	204	174	173
	65	99	97	96	99
	75	42	41	41	45
	85	6	6	5	9
	90	0	0	0	

LUMEN SUMMARY	ZONE	LUMENS	% FIXTURE
	0 - 30	854	44
	0 - 40	1324	68
	0 - 60	1802	92
	0 - 90	1955	100
	0 - 180	1955	100

M4PS-L20/9DW-DIM-UNV-LM-OF-WH Total Luminaire Output: 2021 lumens; 37.7 Watts | Efficacy: 53.6 lm/W | 95.0 CRI; 3000K CCT

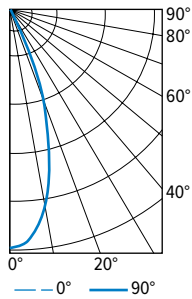

CANDLEPOWER DISTRIBUTION	VERTICAL ANGLE	HORIZONTAL ANGLE			ZONAL LUMENS
		0°	45°	90°	
	0	4343	4343	4343	
	5	4200	4188	4202	385
	15	2875	2876	2855	777
	25	995	990	992	487
	35	290	293	308	198
	45	107	116	113	90
	55	48	53	49	46
	65	23	25	25	24
	75	10	10	11	11
	85	0	1	1	2
	90	0	0	0	

LUMEN SUMMARY	ZONE	LUMENS	% FIXTURE
	0 - 30	1648	82
	0 - 40	1847	91
	0 - 60	1983	98
	0 - 90	2021	100
	0 - 180	2021	100

M4PS-L20/9DW-DIM-UNV-LN-OF-WH Total Luminaire Output: 1956 lumens; 37.7 Watts | Efficacy: 51.9 lm/W | 95.0 CRI; 3000K CCT

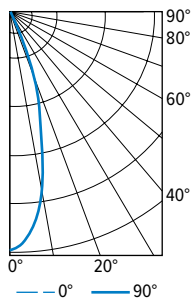

CANDLEPOWER DISTRIBUTION	VERTICAL ANGLE	HORIZONTAL ANGLE			ZONAL LUMENS
		0°	45°	90°	
	0	5104	5104	5104	
	5	4807	4766	4753	429
	15	2695	2727	2680	750
	25	831	904	883	427
	35	230	248	261	167
	45	99	105	108	83
	55	56	61	59	54
	65	27	32	30	30
	75	10	12	12	13
	85	0	1	1	2
	90	0	0	0	

LUMEN SUMMARY	ZONE	LUMENS	% FIXTURE
	0 - 30	1607	82
	0 - 40	1774	91
	0 - 60	1911	98
	0 - 90	1956	100
	0 - 180	1956	100



M4PS dim to WARM

4.5" MRI Shallow Plenum Downlight – Square

FLANGE TYPE DETAILS

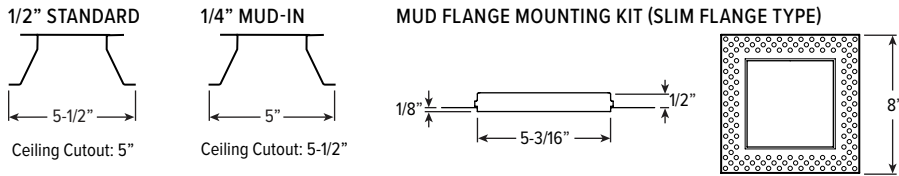

REFLECTOR FINISH DETAILS

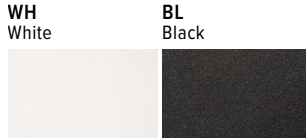

MOUNTING TYPE DETAILS

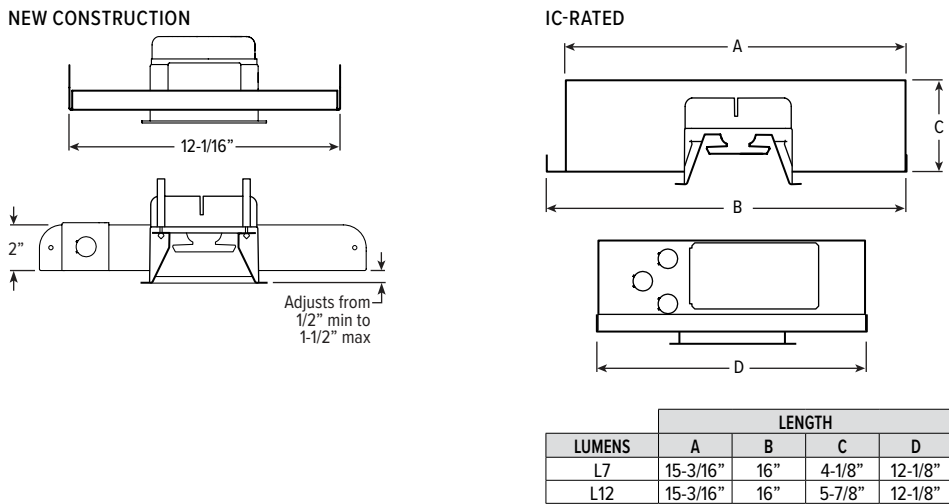

MOUNTING HARDWARE DETAILS

F1M 2-Position fixed pan bracket, aluminum, universal bar hanger included

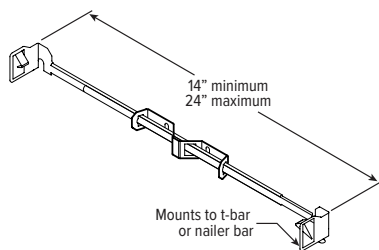

BA1M Adjustable butterfly pan bracket, aluminum, bar hanger not included

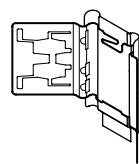

CA1M Adjustable caterpillar pan bracket, aluminum, universal bar hanger included

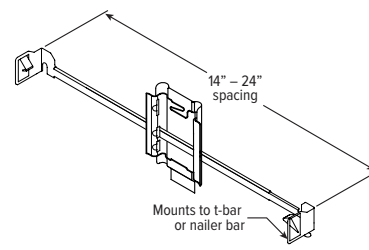

M4PS dim to WARM

4.5" MRI Shallow Plenum Downlight – Square

REMOTE DRIVER ENCLOSURE DETAILS (ORDERED & SHIPPED SEPARATELY)

Remote driver enclosure for single fixture

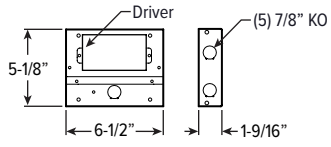

Remote driver enclosure for single fixture with EM/12W

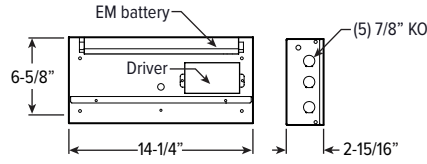

Remote driver enclosure for 2 - 8 fixtures

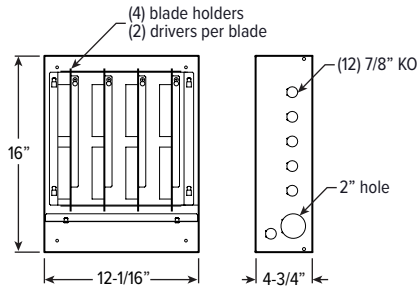

Remote driver enclosure for 9 - 12 fixtures

