

M4PS tunable WHITE 4.5" MRI Shallow Plenum Downlight – Square

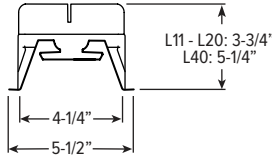

Pan Size: 12-1/16" x 16-1/4"

CATALOG #: _____

TYPE: _____

PROJECT: _____

FEATURES

- Tunable white from 2700K to 5000K CCT, minimum 80 CRI
- Designed with non-ferrous materials for MRI imaging suites
- IP65-rated die-cast trim includes easy-to-clean flush lens
- Slim 5" depth for minimal plenum space applications
- Beam angles ranging from 30° narrow to 75° wide for tailored performance
- 4 inch aperture is unobtrusive in small scale spaces
- Square shape accentuates architectural styles
- Spring clip retention system eliminates trim sag
- Contemporary design provides glare-free illumination for a soft ceiling appearance
- Fully room-side accessible

SPECIFICATIONS

- HOUSING** – Spun housing with forged aluminum heat sink. Aluminum splice compartment. Trim housing adjusts for ceiling thickness from 1/2" - 1-1/2".
- LENSED TRIM** – Die-cast aluminum frame with micro-prismatic, tempered glass lens.
- ELECTRICAL** – High-performance Class 2 C.O.B. LED array. Modular quick-connect plug for easy field-connection of LED light assembly to splice compartment. Reported L70>50,000 hours. Tunable White products use LEDs of multiple CCTs and may produce a perceptibly different shade of white from single-CCT products at the same CCT. All CCTs are within 3 MacAdam ellipses.
- MOUNTING** – Recessed. Aluminum mounting pan for new construction or IC-rated enclosure. Remote mounted driver enclosure required, ordered separately, must be located outside MRI room.
- LISTINGS** –
 - cCSAus conforms to UL STD 1598; Certified to CAN/CSA STD C22.2 No. 250.0 for damp locations. LED light assembly conforms to UL 2108 for remote installation.
 - Suitable for wet location under covered ceiling when specified with WET/CC option.
 - IC-rated for direct contact with insulation when specified with I Mounting Type.
 - City of Chicago Environmental Air approved when specified with CP option.
 - Complies with ASTM-E283 when specified with ATH option.
 - RoHS compliant.
- WARRANTY** – 5-year limited warranty, see hew.com/warranty.

ORDERING EXAMPLE:⁽¹⁾ **M4PS - L20/8TW - OPTIONS - LW - OF - WH - TRIM OPTIONS - N - F1M**

HOUSING
TRIM
MOUNT.

HOUSING

SERIES	LUMENS ⁽²⁾	COLOR	OPTIONS
M4PS	L11 1,100lm	8TW Tunable white (80 CRI, 2700K-5000K)	ATH Airtight construction ⁽³⁾
	L20 2,000lm		CP Chicago plenum (CCEA) ⁽⁴⁾
	L40 4,000lm		

TRIM

TRIM TYPE	DISTRIBUTION ⁽⁵⁾	FLANGE TYPE	REFLECTOR FINISH	TRIM OPTIONS
L Flush lens	W 75° Wide	OF 1/2" standard flange	CS Clear semi-specular powder coat	IP IP65 rated trim
	M 35° Medium			AD Diffuse acrylic lens ⁽⁷⁾
	N 30° Narrow	SF 1/4" mud-in flange ⁽⁶⁾	WH White texture powder coat	PD Diffuse 1/8" polycarbonate lens ⁽⁸⁾
			BL Black texture powder coat	WET/CC Wet location, covered ceiling listed ⁽⁹⁾

MOUNTING

MOUNTING TYPE⁽¹⁰⁾

- N Open pan for new construction
- I IC-rated enclosure for new construction⁽¹²⁾

MOUNTING HARDWARE⁽¹¹⁾

- F1M 2-Position fixed pan bracket, aluminum, universal bar hanger included
- BA1M Adjustable butterfly pan bracket, aluminum, bar hanger not included⁽¹³⁾
- CA1M Adjustable caterpillar pan bracket, aluminum, universal bar hanger included

REMOTE DRIVER ENCLOSURE (ORDERED SEPARATELY)⁽¹⁴⁾

ORDERING EXAMPLE: **M4PS - RDB1 - L18 - OPTIONS - DIM - UNV**

SERIES	DRIVER BOX	DRIVER QTY.	LUMENS	OPTIONS	CONTROL ⁽¹⁵⁾	VOLTAGE	
M4PS	RDB Remote driver enclosure	1 7	L11 1,100lm	EM/12W 12-watt emergency battery ⁽¹⁶⁾	DALI Driver prewired for DALI applications	UNV 120-277V	
		2 8	L18 1,800lm				
		3 9	L32 3,200lm	F Fuse kit			
		4 10					
		5 11					SDT Stepdown transformer ⁽¹⁷⁾
		6 12					
					DIM Dimming driver with (1) 0-10V signal to control dimming and (1) 0-10V signal to control CCT		
					DMX Driver prewired for DMX applications		

NOTES

- Housing, trim, and mounting ship separately.
- Lumen output based on W distribution and WH finish, 4000K/80CRI. Actual lumens may vary +/-5%, see page 2 for FIXTURE PERFORMANCE DATA.
- I Mounting Type required.
- I Mounting Type required.
- Beam angle based on WH reflector finish.
- For use with mud-in plaster construction only, supplied with mud flange installation kit, see page 3 for FLANGE TYPE DETAILS, not available with ATH, CP or IP options.
- Wide distribution only.
- Wide distribution only.
- Reduces lumen output, use .85 multiplier.
- Mounting hardware required, ordered separately, see MOUNTING HARDWARE ordering info. See page 3 for MOUNTING TYPE DETAILS.
- See page 3 for MOUNTING HARDWARE DETAILS.
- L20 lumen package max.
- N Mounting Type only.
- Required. Ordered as a separate catalog number, ships separately. See page 4 for REMOTE DRIVER ENCLOSURE DETAILS.
- All drivers dimmed by single control signal.
- Available with RDB1 only.
- May be required for 347V, see product builder at hew.com
- Not available with EM batteries.



M4PS tunable WHITE 4.5" MRI Shallow Plenum Downlight – Square

FIXTURE PERFORMANCE DATA

LED PACKAGE	DISTRIBUTION	DELIVERED LUMENS	WATTAGE	EFFICACY (lm/W)
L11	W	1156	14.6	79.4
	M	1197	14.6	82.2
	N	1158	14.6	79.6
L20	W	2016	24.0	84.0
	M	2087	24.0	87.0
	N	2019	24.0	84.1
L40	W	4076	46.7	87.2
	M	4220	46.7	90.3
	N	4082	46.7	87.4

MULTIPLIER TABLE

COLOR TEMPERATURE		
CCT	LUMENS	WATTS
2700K	0.83	1.03
3000K	1.00	1.00
3500K	0.99	0.99
4000K	1.00	1.00
5000K	0.98	1.03

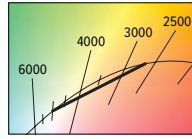

- Photometrics tested in accordance with IESNA LM-79. Results shown are based on 25°C ambient temperature.
- Wattage shown is based on 120V input.
- Results based on 4000K, 80 CRI, actual lumens may vary +/-5%
- Use multiplier tables to calculate additional options.

PHOTOMETRY

M4PS-L20/8TW-DIM-UNV-LW-OF-WH Total Luminaire Output: 2016 lumens; 24.0 Watts | Efficacy: 84.0 lm/W | 80.0 CRI; 4000K CCT

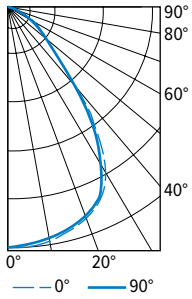

CANDLEPOWER DISTRIBUTION	VERTICAL ANGLE	HORIZONTAL ANGLE			ZONAL LUMENS
		0°	45°	90°	
	0	1134	1134	1134	
	5	1134	1128	1128	
	15	1093	1088	1084	107
	25	1022	1025	1011	466
	35	726	864	706	485
	45	327	504	315	315
	55	187	210	180	179
	65	102	100	99	102
	75	43	43	43	47
	85	6	6	5	9
	90	0	0	0	

LUMEN SUMMARY	ZONE	LUMENS	% FIXTURE
	0 - 30	880	44
	0 - 40	1365	68
	0 - 60	1858	92
	0 - 90	2016	100
	0 - 180	2016	100

M4PS-L20/8TW-DIM-UNV-LM-OF-WH Total Luminaire Output: 2087 lumens; 24.0 Watts | Efficacy: 87.0 lm/W | 80.0 CRI; 4000K CCT

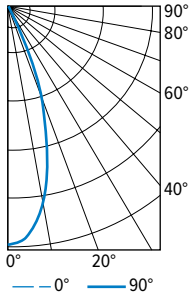

CANDLEPOWER DISTRIBUTION	VERTICAL ANGLE	HORIZONTAL ANGLE			ZONAL LUMENS
		0°	45°	90°	
	0	4486	4486	4486	
	5	4338	4326	4340	397
	15	2970	2970	2949	802
	25	1027	1023	1024	503
	35	300	302	318	205
	45	111	120	117	93
	55	49	54	51	48
	65	24	26	26	25
	75	10	10	12	11
	85	0	1	1	2
	90	0	0	0	

LUMEN SUMMARY	ZONE	LUMENS	% FIXTURE
	0 - 30	1702	82
	0 - 40	1907	91
	0 - 60	2049	98
	0 - 90	2087	100
	0 - 180	2087	100

M4PS-L20/8TW-DIM-UNV-LN-OF-WH Total Luminaire Output: 2019 lumens; 24.0 Watts | Efficacy: 84.1 lm/W | 80.0 CRI; 4051K CCT

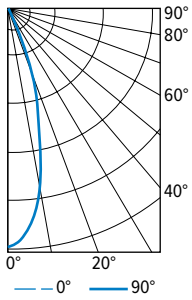

CANDLEPOWER DISTRIBUTION	VERTICAL ANGLE	HORIZONTAL ANGLE			ZONAL LUMENS
		0°	45°	90°	
	0	5270	5270	5270	
	5	4963	4920	4907	443
	15	2782	2815	2767	775
	25	858	934	912	441
	35	238	256	270	173
	45	102	108	112	86
	55	58	63	61	55
	65	28	33	31	31
	75	11	13	13	13
	85	0	1	1	2
	90	0	0	0	

LUMEN SUMMARY	ZONE	LUMENS	% FIXTURE
	0 - 30	1659	82
	0 - 40	1831	91
	0 - 60	1973	98
	0 - 90	2019	100
	0 - 180	2019	100



M4PS tunable WHITE 4.5" MRI Shallow Plenum Downlight – Square

FLANGE TYPE DETAILS

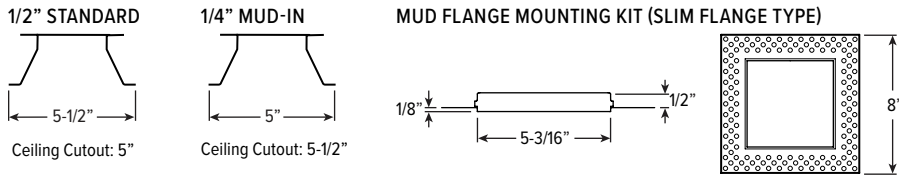

REFLECTOR FINISH DETAILS

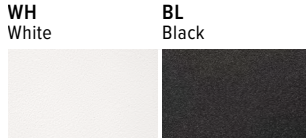

MOUNTING TYPE DETAILS

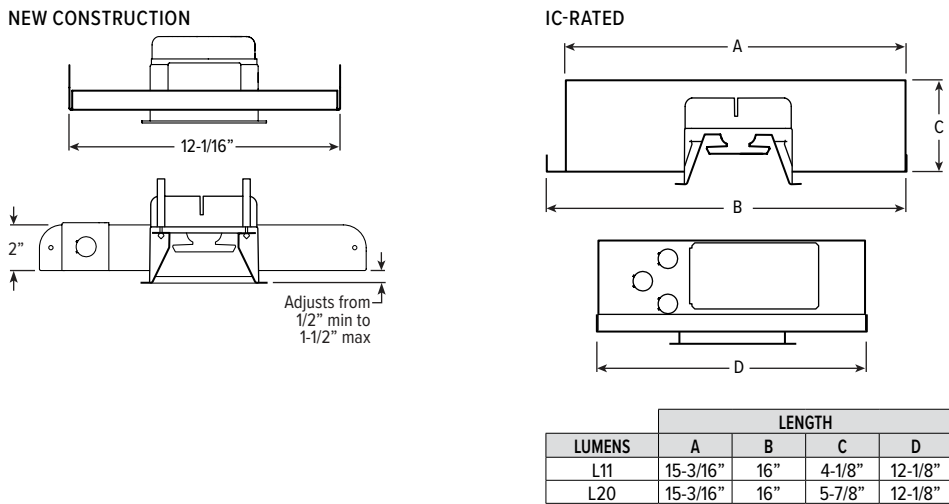

MOUNTING HARDWARE DETAILS

F1M 2-Position fixed pan bracket, aluminum, universal bar hanger included

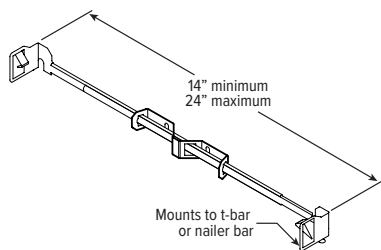

BA1M Adjustable butterfly pan bracket, aluminum, bar hanger not included

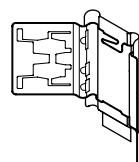

CA1M Adjustable caterpillar pan bracket, aluminum, universal bar hanger included

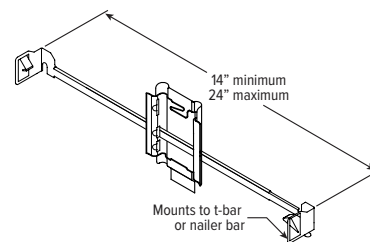

M4PS tunable WHITE 4.5" MRI Shallow Plenum Downlight – Square

REMOTE DRIVER ENCLOSURE DETAILS (ORDERED & SHIPPED SEPARATELY)

Remote driver enclosure for single fixture

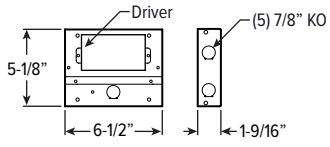

Remote driver enclosure for single fixture with EM/12W

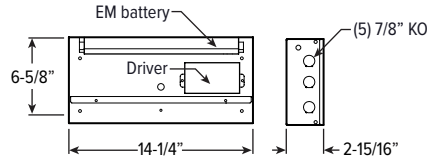

Remote driver enclosure for 2 - 8 fixtures

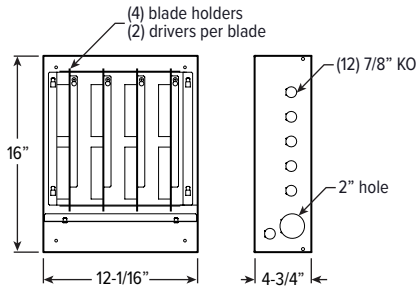

Remote driver enclosure for 9 - 12 fixtures

