

M6PR dim to **WARM** 6" MRI Shallow Plenum Downlight – Round

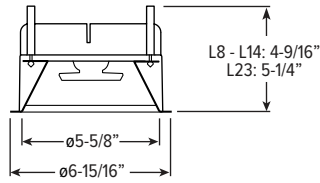

Pan Size: 12-1/6" x 16-1/4"

CATALOG #: _____

TYPE: _____

PROJECT: _____

FEATURES

TrimLock™

- Williams TrimLock reflector retention system eliminates trim sag
- Dim to warm from 1800K to 3000K CCT, minimum 95 CRI
- Designed with non-ferrous materials for MRI imaging suites
- IP65-rated die-cast trim includes easy-to-clean flush lens
- Slim 5" depth for minimal plenum space applications
- Beam angles ranging from 25° narrow to 85° wide for tailored performance
- Contemporary design provides glare-free illumination for a soft ceiling appearance
- Fully room-side accessible

SPECIFICATIONS

- HOUSING** – Spun housing with forged aluminum heat sink. Aluminum splice compartment. Trim housing adjusts for ceiling thickness from 1/2" - 1-1/2".
- TRIMLOCK** – Innovative TrimLock reflector retention system ensures the trim remains flush with the ceiling plane.
- LENSED TRIM** – Die-cast aluminum frame with micro-prismatic, tempered glass lens.
- ELECTRICAL** – Five color, mid-power LED modules. On board thermal and optical feedback ensure color consistency of <2 step MacAdam ellipse (SDCM). In-line spectral capture and storage results in consistent CRI and CCT across all arrays. Reported L70>55,000 hours. Reported L90>55,000 hours. Estimated L70 = 200,000 hours. Remote mounted driver box must be located outside MRI room.
- MOUNTING** – Recessed. Aluminum mounting pan for new construction or IC-rated enclosure. Remote mounted driver enclosure required, ordered separately, must be located outside MRI room.
- LISTINGS** –
 - cCSAus conforms to UL STD 1598; Certified to CAN/CSA STD C22.2 No. 250.0 for damp locations. LED light assembly conforms to UL 2108 for remote installation.
 - Suitable for wet location under covered ceiling when specified with WET/CC option.
 - IC-rated for direct contact with insulation when specified with I Mounting Type.
 - City of Chicago Environmental Air approved when specified with CP option.
 - Complies with ASTM-E283 when specified with ATH option.
 - RoHS compliant.
- WARRANTY** – 5-year limited warranty, see hew.com/warranty.

ORDERING EXAMPLE:^[1] **M6PR - TL - L23/9DW - OPTIONS - LW - OF - WH - TRIM OPTIONS - N - F1M**
HOUSING TRIM MOUNT.

HOUSING

SERIES	LUMENS ^[2]	COLOR	OPTIONS
M6PR-TL	L8 800lm	9DW Dim to warm (95 CRI, 1800K – 3000K)	ATH Airtight construction ^[3]
TrimLock	L14 1,400lm L23 2,300lm		CP Chicago plenum (CCEA) ^[4]

TRIM

TRIM TYPE	DISTRIBUTION ^[5]	FLANGE TYPE	REFLECTOR FINISH	TRIM OPTIONS
L Flush lens	W 85° Wide M 35° Medium N 25° Narrow	OF 1/2" standard flange SF 1/4" mud-in flange ^[6]	WH White texture powder coat BL Black texture powder coat	IP IP65 rated trim AD Diffuse acrylic lens ^[7] WET/CC Wet location, covered ceiling listed

MOUNTING

MOUNTING TYPE ^[8]	MOUNTING HARDWARE ^[9]
N Open pan for new construction	F1M 2-Position fixed pan bracket, aluminum, universal bar hanger included
I IC-rated enclosure for new construction ^[10]	BA1M Adjustable butterfly pan bracket, aluminum, bar hanger not included ^[11] CA1M Adjustable caterpillar pan bracket, aluminum, universal bar hanger included

REMOTE DRIVER ENCLOSURE (ORDERED SEPARATELY)^[12]

ORDERING EXAMPLE: **M6PR - RDB1 - L23 - OPTIONS - DIM - UNV**

SERIES	DRIVER BOX	DRIVER QTY.	LUMENS	OPTIONS	CONTROL ^[13]	VOLTAGE	
M6PR	RDB Remote driver enclosure	1	7	L8 800lm	EM/12W 12-watt emergency battery ^[14]	DIM Dimming driver (0-10V signal to control dimming and CCT)	UNV 120-277V 347 347V ^[16]
		2	8	L14 1,400lm			
		3	9	L23 2,300lm			
		4	10	F Fuse kit SDT Stepdown transformer ^[15]			
		5	11				
		6	12		LUT Lutron Ecosystem enabled		

NOTES

- Housing, trim, and mounting ship separately.
- Lumen output based on full light output, W distribution and WH finish, 3000K/95CRI. Actual lumens may vary +/-5%, see page 2 for FIXTURE PERFORMANCE DATA.
- I Mounting Type required.
- I Mounting Type required.
- Beam angle based on WH reflector finish.
- For use with mud-in plaster construction only, supplied with mud flange installation kit, see page 3 for FLANGE TYPE DETAILS, not available with ATH, CP or IP options.
- Wide distribution only.
- Mounting hardware required, ordered separately, see MOUNTING HARDWARE ordering info. See page 3 for MOUNTING TYPE DETAILS.
- See page 3 for MOUNTING HARDWARE DETAILS.
- L14 lumen package max.
- N Mounting Type only.
- Required. Ordered as a separate catalog number, ships separately. See page 4 for REMOTE DRIVER ENCLOSURE DETAILS.
- All drivers dimmed by single control signal.
- Available with RDB1 only.
- May be required for 347V, see product builder at hew.com
- Not available with EM batteries.



M6PR dim to WARM 6" MRI Shallow Plenum Downlight – Round

FIXTURE PERFORMANCE DATA

LED PACKAGE	DISTRIBUTION	DELIVERED LUMENS	CCT AT 100% (FULL OUTPUT)	CCT AT 1% (FULL DIM)	WATTAGE	EFFICACY (lm/W)
L8	W	806	3000K	1800K	14.0	57.6
	M	817			14.0	58.4
	N	825			14.0	58.9
L14	W	1413			23.4	60.4
	M	1433			23.4	61.2
	N	1446			23.4	61.8
L23	W	2314			37.7	61.4
	M	2347			37.7	62.3
	N	2369			37.7	62.8

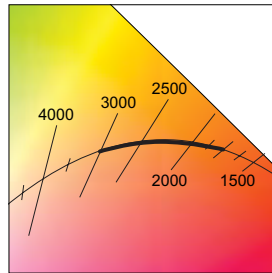

- Photometrics tested in accordance with IESNA LM-79. Results shown are based on 25°C ambient temperature.
- Wattage shown is based on 120V input.
- Results based on 3000K, 95 CRI, full output, actual lumens may vary +/-5%
- Use multiplier table to calculate additional options.

PHOTOMETRY

M6PR-L23/9DW-DIM-UNV-LW-OF-WH Total Luminaire Output: 2314 lumens; 37.7 Watts | Efficacy: 61.4 lm/W | 95.0 CRI; 3000K CCT

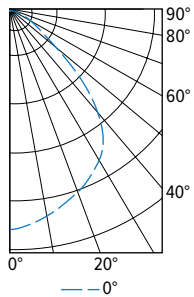

CANDLEPOWER DISTRIBUTION	VERTICAL ANGLE	HORIZONTAL ANGLE	ZONAL LUMENS
		0°	
	0	1225	
	5	1203	114
	15	1127	318
	25	1036	477
	35	901	557
	45	582	442
	55	233	218
	65	116	117
	75	53	57
	85	12	15
	90	1	

LUMEN SUMMARY	ZONE	LUMENS	% FIXTURE
	0 - 40	1466	63
	0 - 60	2126	92
	0 - 90	2314	100
	0 - 180	2314	100

M6PR-L23/9DW-DIM-UNV-LM-OF-WH Total Luminaire Output: 2347 lumens; 37.7 Watts | Efficacy: 62.3 lm/W | 95.0 CRI; 3000K CCT

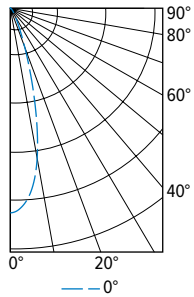

CANDLEPOWER DISTRIBUTION	VERTICAL ANGLE	HORIZONTAL ANGLE	ZONAL LUMENS
		0°	
	0	5398	
	5	5188	476
	15	3397	913
	25	1074	512
	35	319	209
	45	140	110
	55	73	66
	65	37	37
	75	18	19
	85	3	4
	90	0	

LUMEN SUMMARY	ZONE	LUMENS	% FIXTURE
	0 - 40	2110	90
	0 - 60	2286	97
	0 - 90	2347	100
	0 - 180	2347	100

M6PR-L23/9DW-DIM-UNV-LN-OF-WH Total Luminaire Output: 2369 lumens; 37.7 Watts | Efficacy: 62.8 lm/W | 95.0 CRI; 3000K CCT

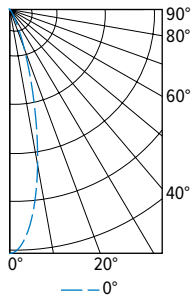

CANDLEPOWER DISTRIBUTION	VERTICAL ANGLE	HORIZONTAL ANGLE	ZONAL LUMENS
		0°	
	0	8749	
	5	7909	686
	15	3390	933
	25	808	392
	35	223	147
	45	112	88
	55	69	62
	65	38	38
	75	17	18
	85	3	4
	90	0	

LUMEN SUMMARY	ZONE	LUMENS	% FIXTURE
	0 - 40	2159	91
	0 - 60	2308	97
	0 - 90	2369	100
	0 - 180	2369	100

M6PR dim to **WARM** 6" MRI Shallow Plenum Downlight – Round

TRIMLOCK DETAILS



FLANGE TYPE DETAILS

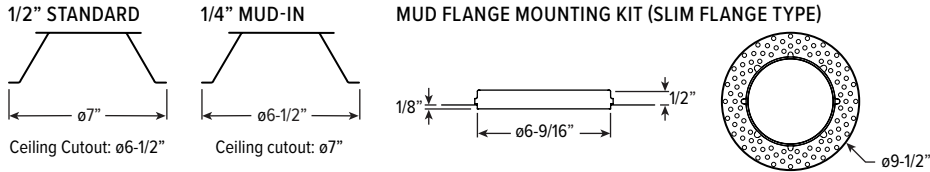

REFLECTOR FINISH DETAILS

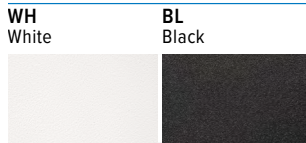

MOUNTING TYPE DETAILS

NEW CONSTRUCTION

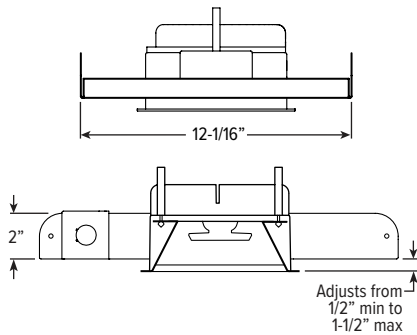

IC-RATED

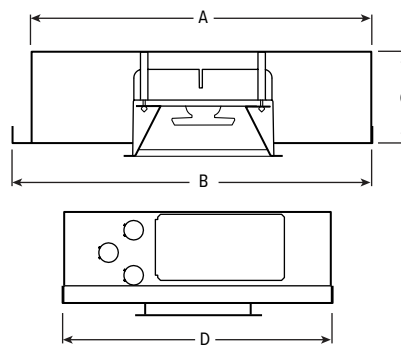

LUMENS	LENGTH			
	A	B	C	D
L8	15-3/16"	16"	4-1/8"	12-1/8"
L14	15-3/16"	16"	5-7/8"	12-1/8"

MOUNTING HARDWARE DETAILS

F1M 2-Position fixed pan bracket, aluminum, universal bar hanger included

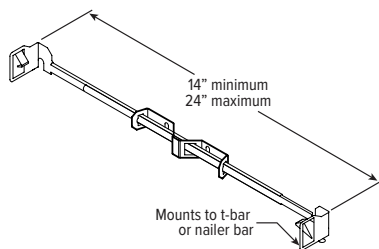

BA1M Adjustable butterfly pan bracket, aluminum, bar hanger not included

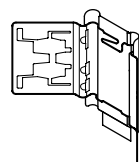

CA1M Adjustable caterpillar pan bracket, aluminum, universal bar hanger included

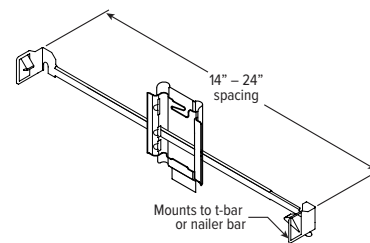

M6PR dim to **WARM** 6" MRI Shallow Plenum Downlight – Round

REMOTE DRIVER ENCLOSURE DETAILS (ORDERED & SHIPPED SEPARATELY)

Remote driver enclosure for single fixture

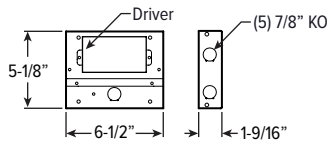

Remote driver enclosure for single fixture with EM/12W

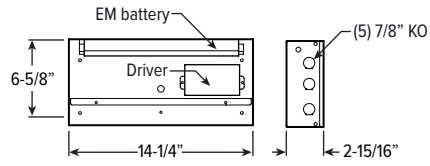

Remote driver enclosure for 2 - 8 fixtures

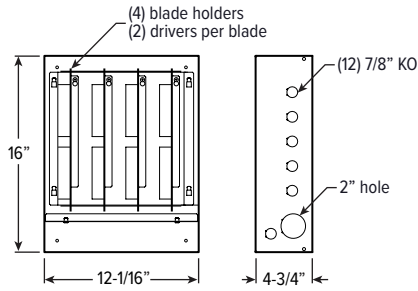

Remote driver enclosure for 9 - 12 fixtures

