

M6PR tunable WHITE 6" MRI Shallow Plenum Downlight – Round

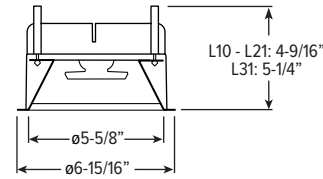

Pan Size: 12-1/6" x 16-1/4"

CATALOG #: _____

TYPE: _____

PROJECT: _____

FEATURES

TrimLock™

- Williams TrimLock reflector retention system eliminates trim sag
- Tunable white from 2700K to 5000K CCT, minimum 80 CRI
- Designed with non-ferrous materials for MRI imaging suites
- IP65-rated die-cast trim includes easy-to-clean flush lens
- Slim 5" depth for minimal plenum space applications
- Beam angles ranging from 25° narrow to 85° wide for tailored performance
- Contemporary design provides glare-free illumination for a soft ceiling appearance
- Fully room-side accessible

SPECIFICATIONS

- HOUSING** – Spun housing with forged aluminum heat sink. Aluminum splice compartment. Trim housing adjusts for ceiling thickness from 1/2" - 1-1/2".
- TRIMLOCK** – Innovative TrimLock reflector retention system ensures the trim remains flush with the ceiling plane.
- LENSED TRIM** – Die-cast aluminum frame with micro-prismatic, tempered glass lens.
- ELECTRICAL** – High-performance Class 2 C.O.B. LED array. Modular quick-connect plug for easy field-connection of LED light assembly to splice compartment. Reported L70>50,000 hours. Tunable White products use LEDs of multiple CCTs and may produce a perceptibly different shade of white from single-CCT products at the same CCT. All CCTs are within 3 MacAdam ellipses.
- MOUNTING** – Recessed. Aluminum mounting pan for new construction or IC-rated enclosure. Remote mounted driver enclosure required, ordered separately, must be located outside MRI room.
- LISTINGS** –
 - cCSAus conforms to UL STD 1598; Certified to CAN/CSA STD C22.2 No. 250.0 for damp locations. LED light assembly conforms to UL 2108 for remote installation.
 - Suitable for wet location under covered ceiling when specified with WET/CC option.
 - IC-rated for direct contact with insulation when specified with I Mounting Type.
 - City of Chicago Environmental Air approved when specified with CP option.
 - Complies with ASTM-E283 when specified with ATH option.
 - RoHS compliant.
- WARRANTY** – 5-year limited warranty, see hew.com/warranty.

ORDERING EXAMPLE:^[1] **M6PR - TL - L10/8TW - OPTIONS** - **LW - OF - WH - TRIM OPTIONS** - **N - F1M**
 HOUSING TRIM MOUNT.

HOUSING

SERIES	LUMENS ^[2]	COLOR	OPTIONS
M6PR-TL	L10 1,000lm	8TW Tunable white (80 CRI, 2700K-5000K)	ATH Airtight construction ^[3]
TrimLock	L21 1,700lm		CP Chicago plenum (CCEA) ^[4]
	L43 4,300lm		

TRIM

TRIM TYPE	DISTRIBUTION ^[5]	FLANGE TYPE	REFLECTOR FINISH	TRIM OPTIONS
L Flush lens	W 85° Wide M 35° Medium N 25° Narrow	OF 1/2" standard flange SF 1/4" mud-in flange ^[6]	CS Clear semi-specular powder coat WH White texture powder coat BL Black texture powder coat	IP IP65 rated trim AD Diffuse acrylic lens ^[7] PD Diffuse 1/8" polycarbonate lens ^[8] WET/CC Wet location, covered ceiling listed ^[9]

MOUNTING

MOUNTING TYPE ^[10]	MOUNTING HARDWARE ^[11]
N Open pan for new construction	F1M 2-Position fixed pan bracket, aluminum, universal bar hanger included
I IC-rated enclosure for new construction ^[12]	BA1M Adjustable butterfly pan bracket, aluminum, bar hanger not included ^[13]
	CA1M Adjustable caterpillar pan bracket, aluminum, universal bar hanger included

REMOTE DRIVER ENCLOSURE (ORDERED SEPARATELY)^[14]

ORDERING EXAMPLE: M6PR - RDB1 - L10 - OPTIONS - DIM - UNV						
SERIES	DRIVER BOX	DRIVER QTY.	LUMENS	OPTIONS	CONTROL ^[15]	VOLTAGE
M6PR	RDB Remote driver enclosure	1 7	L10 1,000lm	EM/12W 12-watt emergency battery ^[16]	DALI Driver prewired for DALI applications	UNV 120-277V 347 347V ^[18]
		2 8	L21 1,700lm			
		3 9	L43 4,300lm			
		4 10		F Fuse kit		
		5 11				
		6 12				
					DIM Dimming driver with (1) 0-10V signal to control dimming and (1) 0-10V signal to control CCT	
					DMX Driver prewired for DMX applications	

NOTES

- Housing, trim, and mounting ship separately.
- Lumen output based on W distribution and WH finish, 4000K/80CRI. Actual lumens may vary +/-5%, see page 2 for FIXTURE PERFORMANCE DATA.
- I Mounting Type required.
- I Mounting Type required.
- Beam angle based on WH reflector finish.
- For use with mud-in plaster construction only, supplied with mud flange installation kit, see page 3 for FLANGE TYPE DETAILS, not available with ATH, CP or IP options.
- Wide distribution only.
- Wide distribution only.
- Reduces lumen output, use .85 multiplier.
- Mounting hardware required, ordered separately, see MOUNTING HARDWARE ordering info. See page 3 for MOUNTING TYPE DETAILS.
- See page 3 for MOUNTING HARDWARE DETAILS.
- L21 lumen package max.
- N Mounting Type only.
- Required. Ordered as a separate catalog number, ships separately. See page 4 for REMOTE DRIVER ENCLOSURE DETAILS.
- All drivers dimmed by single control signal.
- Available with RDB1 only.
- May be required for 347V, see product builder at hew.com
- Not available with EM batteries.



M6PR tunable WHITE 6" MRI Shallow Plenum Downlight – Round

FIXTURE PERFORMANCE DATA

LED PACKAGE	DISTRIBUTION	DELIVERED LUMENS	WATTAGE	EFFICACY (lm/W)
L10	W	1148	14.6	78.6
	M	1164	14.6	79.7
	N	1175	14.6	80.5
L21	W	2152	24.0	89.5
	M	2182	24.0	90.7
	N	2107	24.0	87.6
L43	W	4352	46.7	93.1
	M	4411	46.7	94.4
	N	4261	46.7	91.2

MULTIPLIER TABLE

COLOR TEMPERATURE		
CCT	LUMENS	WATTS
2700K	0.83	1.03
3000K	1.00	1.00
3500K	0.99	0.99
4000K	1.00	1.00
5000K	0.98	1.03

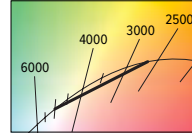

- Photometrics tested in accordance with IESNA LM-79. Results shown are based on 25°C ambient temperature.
- Wattage shown is based on 120V input.
- Results based on 4000K, 80 CRI, actual lumens may vary +/-5%
- Use multiplier tables to calculate additional options.

PHOTOMETRY

M6PR-TL-L10/8TW-DIM-UNV-LW-OF-WH Total Luminaire Output: 1148 lumens; 14.6 Watts | Efficacy: 78.6 lm/W | 80.0 CRI; 4037K CCT

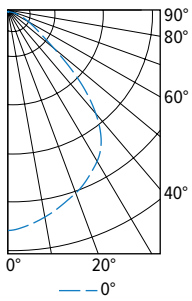

CANDLEPOWER DISTRIBUTION	VERTICAL ANGLE	HORIZONTAL ANGLE	ZONAL LUMENS
		0°	
	0	608	
	5	597	56
	15	559	158
	25	514	237
	35	447	276
	45	289	219
	55	116	108
	65	58	58
	75	26	28
	85	6	7
	90	0	

LUMEN SUMMARY	ZONE	LUMENS	% FIXTURE
	0 - 40	728	63
	0 - 60	1055	92
	0 - 90	1148	100
	0 - 180	1148	100

M6PR-TL-L10/8TW-DIM-UNV-LM-OF-WH Total Luminaire Output: 1164 lumens; 14.6 Watts | Efficacy: 79.7 lm/W | 80.0 CRI; 4037K CCT

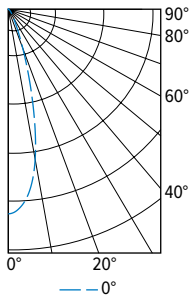

CANDLEPOWER DISTRIBUTION	VERTICAL ANGLE	HORIZONTAL ANGLE	ZONAL LUMENS
		0°	
	0	2679	
	5	2574	236
	15	1685	453
	25	533	254
	35	158	104
	45	70	55
	55	36	33
	65	19	19
	75	9	9
	85	2	2
	90	0	

LUMEN SUMMARY	ZONE	LUMENS	% FIXTURE
	0 - 40	1047	90
	0 - 60	1134	97
	0 - 90	1164	100
	0 - 180	1164	100

M6PR-TL-L10/8TW-DIM-UNV-LN-OF-WH Total Luminaire Output: 1175 lumens; 14.6 Watts | Efficacy: 80.5 lm/W | 80.0 CRI; 4037K CCT

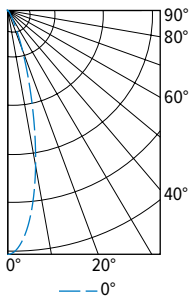

CANDLEPOWER DISTRIBUTION	VERTICAL ANGLE	HORIZONTAL ANGLE	ZONAL LUMENS
		0°	
	0	4341	
	5	3924	341
	15	1682	463
	25	401	195
	35	110	73
	45	56	44
	55	34	31
	65	19	19
	75	8	9
	85	2	2
	90	0	

LUMEN SUMMARY	ZONE	LUMENS	% FIXTURE
	0 - 40	1071	91
	0 - 60	1145	97
	0 - 90	1175	100
	0 - 180	1175	100



M6PR tunable **WHITE** 6" MRI Shallow Plenum Downlight – Round

FLANGE TYPE DETAILS

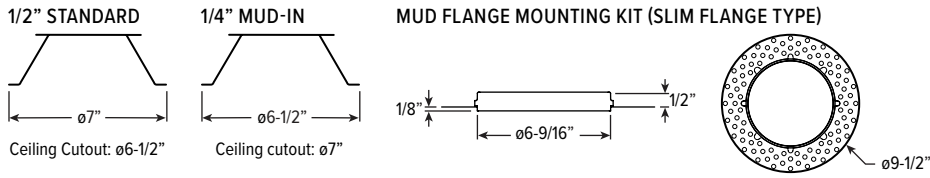

REFLECTOR FINISH DETAILS

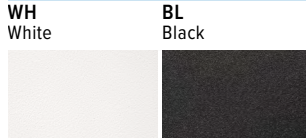

MOUNTING TYPE DETAILS

NEW CONSTRUCTION

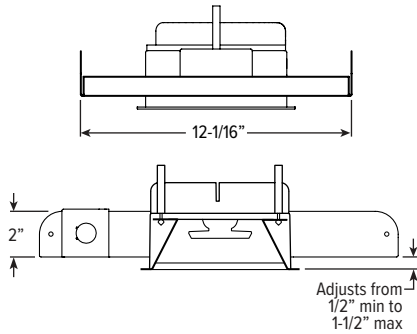

IC-RATED

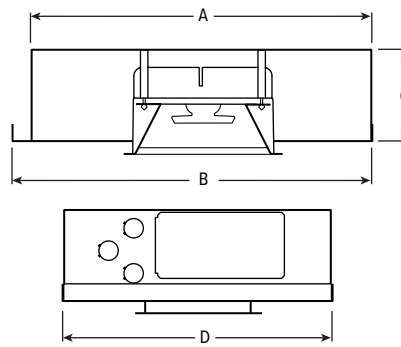

LUMENS	LENGTH			
	A	B	C	D
L10	15-3/16"	16"	4-1/8"	12-1/8"
L21	15-3/16"	16"	5-7/8"	12-1/8"

MOUNTING HARDWARE DETAILS

F1M 2-Position fixed pan bracket, aluminum, universal bar hanger included

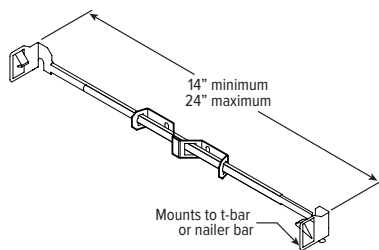

BA1M Adjustable butterfly pan bracket, aluminum, bar hanger not included

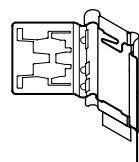

CA1M Adjustable caterpillar pan bracket, aluminum, universal bar hanger included

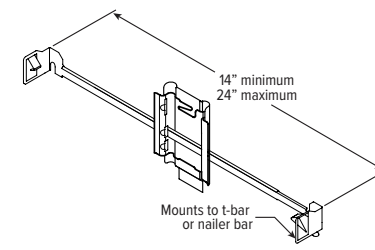

M6PR tunable WHITE 6" MRI Shallow Plenum Downlight – Round

REMOTE DRIVER ENCLOSURE DETAILS (ORDERED & SHIPPED SEPARATELY)

Remote driver enclosure for single fixture

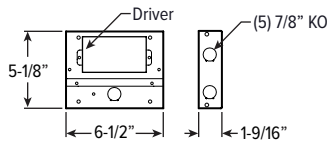

Remote driver enclosure for single fixture with EM/12W

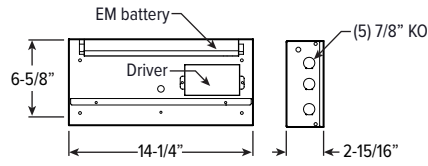

Remote driver enclosure for 2 - 8 fixtures

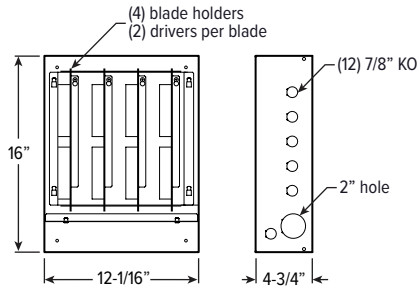

Remote driver enclosure for 9 - 12 fixtures

