

M6PS tunable WHITE 6" MRI Shallow Plenum Downlight – Square

FIXTURE PERFORMANCE DATA

LED PACKAGE	DISTRIBUTION	DELIVERED LUMENS	WATTAGE	EFFICACY (lm/W)
L12	W	1267	14.6	87.0
	M	1203	14.6	82.7
	N	1154	14.6	79.3
L20	W	2205	24.0	91.9
	M	2098	24.0	87.4
	N	2018	24.0	84.1
L42	W	4466	46.7	95.6
	M	4243	46.7	90.8
	N	4067	46.7	87.0

MULTIPLIER TABLE

COLOR TEMPERATURE		
CCT	LUMENS	WATTS
2700K	0.83	1.03
3000K	1.00	1.00
3500K	0.99	0.99
4000K	1.00	1.00
5000K	0.98	1.03

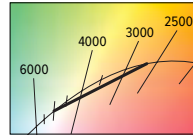

- Photometrics tested in accordance with IESNA LM-79. Results shown are based on 25°C ambient temperature.
- Wattage shown is based on 120V input.
- Results based on 4000K, 80 CRI, actual lumens may vary +/-5%
- Use multiplier tables to calculate additional options.

PHOTOMETRY

M6PS-L20/8TW-DIM-UNV-LW-OF-WH Total Luminaire Output: 2205 lumens; 24.0 Watts | Efficacy: 91.9 lm/W | 80.0 CRI; 4051K CCT

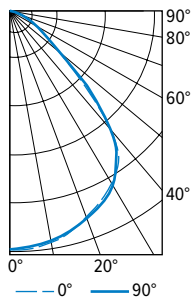

CANDLEPOWER DISTRIBUTION	VERTICAL ANGLE	HORIZONTAL ANGLE			ZONAL LUMENS
		0°	45°	90°	
	0	1091	1091	1091	
	5	1091	1085	1082	103
	15	1052	1044	1047	295
	25	978	968	976	449
	35	868	867	847	533
	45	518	654	513	440
	55	196	307	188	223
	65	94	114	94	104
	75	41	44	42	47
	85	8	7	8	10
	90	0	0	0	

LUMEN SUMMARY	ZONE	LUMENS	% FIXTURE
	0 - 30	848	38
	0 - 40	1380	63
	0 - 60	2043	93
	0 - 90	2205	100
	0 - 180	2205	100

M6PS-L20/8TW-DIM-UNV-LM-OF-WH Total Luminaire Output: 2098 lumens; 24.0 Watts | Efficacy: 87.4 lm/W | 80.0 CRI; 4051K CCT

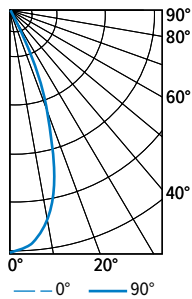

CANDLEPOWER DISTRIBUTION	VERTICAL ANGLE	HORIZONTAL ANGLE			ZONAL LUMENS
		0°	45°	90°	
	0	4312	4312	4312	
	5	4225	4197	4169	387
	15	2964	2989	3007	803
	25	967	1014	1011	495
	35	289	305	306	203
	45	121	130	129	102
	55	61	68	61	59
	65	30	33	30	31
	75	12	13	12	14
	85	1	2	1	3
	90	0	0	0	

LUMEN SUMMARY	ZONE	LUMENS	% FIXTURE
	0 - 30	1686	80
	0 - 40	1889	90
	0 - 60	2050	98
	0 - 90	2098	100
	0 - 180	2098	100

M6PS-L20/8TW-DIM-UNV-LN-OF-WH Total Luminaire Output: 2018 lumens; 24.0 Watts | Efficacy: 84.1 lm/W | 80.0 CRI; 4051K CCT

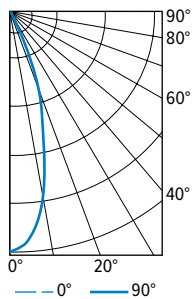

CANDLEPOWER DISTRIBUTION	VERTICAL ANGLE	HORIZONTAL ANGLE			ZONAL LUMENS
		0°	45°	90°	
	0	4898	4898	4898	
	5	4658	4622	4619	418
	15	2723	2748	2731	749
	25	849	907	892	436
	35	252	266	271	180
	45	120	130	129	100
	55	74	85	77	72
	65	41	46	42	44
	75	15	17	15	18
	85	1	1	1	3
	90	0	0	0	

LUMEN SUMMARY	ZONE	LUMENS	% FIXTURE
	0 - 30	1603	79
	0 - 40	1783	88
	0 - 60	1954	97
	0 - 90	2018	100
	0 - 180	2018	100



M6PS tunable WHITE

6" MRI Shallow Plenum Downlight – Square

FLANGE TYPE DETAILS

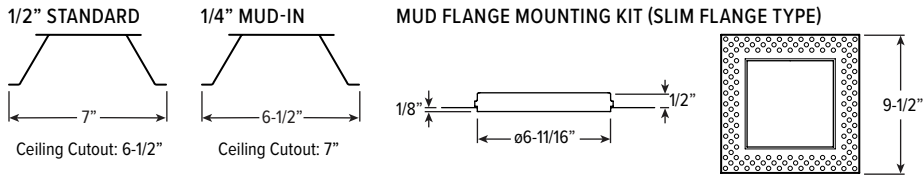

REFLECTOR FINISH DETAILS

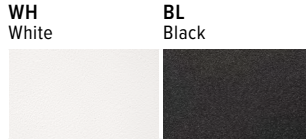

MOUNTING TYPE DETAILS

NEW CONSTRUCTION

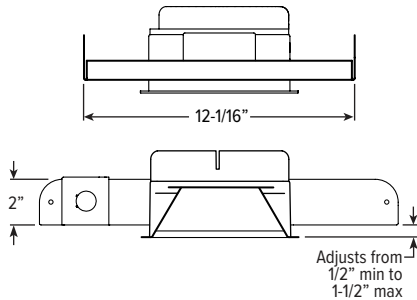

IC-RATED

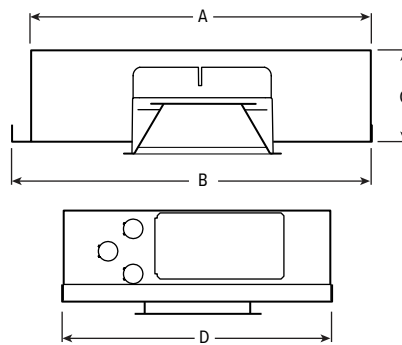

LUMENS	LENGTH			
	A	B	C	D
L12	15-3/16"	16"	4-1/8"	12-1/8"
L20	15-3/16"	16"	5-7/8"	12-1/8"

MOUNTING HARDWARE DETAILS

F1M 2-Position fixed pan bracket, aluminum, universal bar hanger included

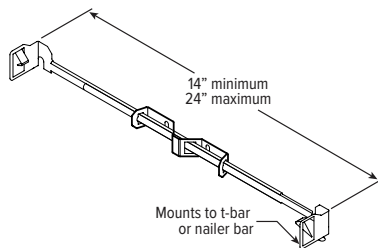

BA1M Adjustable butterfly pan bracket, aluminum, bar hanger not included

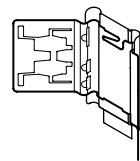

CA1M Adjustable caterpillar pan bracket, aluminum, universal bar hanger included

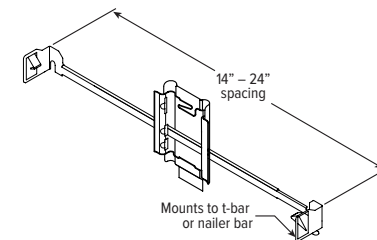

M6PS tunable WHITE 6" MRI Shallow Plenum Downlight – Square

REMOTE DRIVER ENCLOSURE DETAILS (ORDERED & SHIPPED SEPARATELY)

Remote driver enclosure for single fixture

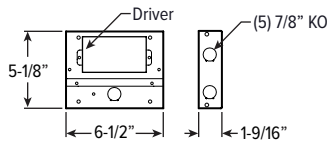

Remote driver enclosure for single fixture with EM/12W

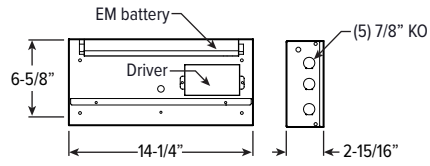

Remote driver enclosure for 2 - 8 fixtures

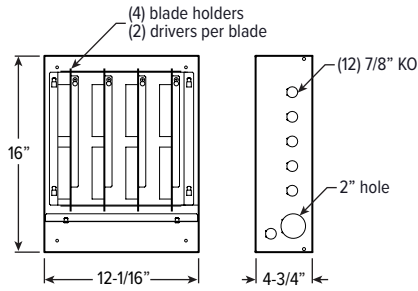

Remote driver enclosure for 9 - 12 fixtures

