

MX4S LED 4" Continuous – Surface

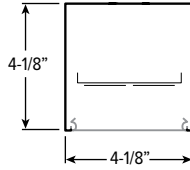
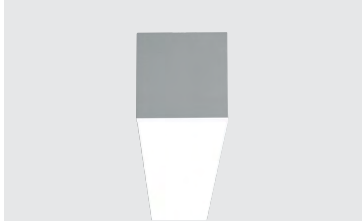

CATALOG #: _____

TYPE: _____

PROJECT: _____

FEATURES

- Create elegant spaces with a seamless, continuous row of illumination
- Flat and proud lenses give designers a variety of looks
- Maximize energy savings with efficacies as high as 113 lm/W
- Linear extrusion contains snap-in light rails for ease of installation and maintenance
- Versatile MX4 system includes recessed, surface, suspended and in-wall mounting, see hew.com
- Corner configurations available, see Product Builder at hew.com/product-builder
- Diffuse acrylic lens provides uniform illumination for visual comfort
- Made Right Here™ in the USA

SPECIFICATIONS

- HOUSING – Extruded aluminum with die-cast end plates.
- SHIELDING – Extruded, flat, diffuse acrylic lens.
- FINISH – Textured matte white polyester TGIC powder coat bonded to phosphate-free, multi-stage pretreated metal. All parts painted after fabrication to facilitate installation, increase efficiency, and inhibit corrosion.
- ELECTRICAL – High quality mid-power LED boards. L70 >60,000 hours per IES TM-21.
- MOUNTING – Surface.
- LISTINGS – cETLus conforms to UL STD 1598. Certified to CAN/CSA STD C22.2 No. 250.0. Suitable for damp locations.
- WARRANTY – 5-year limited warranty, see hew.com/warranty.

ORDERING EXAMPLE: MX4S - 12'00 - L8/835 - F - OPTIONS - DIM - UNV

SERIES LENGTH

MX4S Lengths specified in feet and inches using 4" increments, 2' minimum.
Example: 12'00 = 12'-0"

PRODUCT BUILDER

Easily build shapes & simplify ordering with the Williams Linear Product Builder at hew.com/product-builder^[1]



LUMENS ^[2]	CRI	CCT	SHIELDING	OPTIONS ^[3]
L8 800lm	8 80	27 2700K	F Flat, diffuse acrylic	EM/10W 10-watt emergency battery ^[5]
L12 1200lm	9 90	30 3000K	P Proud, diffuse acrylic with 5/16" drop ^[4]	EM/10WRM Remote mount 10-watt emergency battery ^[6]
L15 1500lm		35 3500K		OCC__ Factory-installed occupancy sensor ^[7] : OCCWS FS-355-L6
		40 4000K		
		50 5000K		

DRIVER ^[8]	VOLTAGE
DIM Dimming driver	120 120V
DRV Non-dimming driver	277 277V
	UNV 120-277V
	347 347V ^[9]

NOTES

- ¹ See page 3 for CORNER DETAILS.
- ² Lumens per foot output based on 3500K CCT and F shielding. Actual lumens may vary ± 5%. See page 2 for FIXTURE PERFORMANCE DATA.
- ³ See page 3 for FINISH OPTIONS. Custom colors available upon request. See Technical Info for [Power Entry](#) details.
- ⁴ See page 3 for SHIELDING DETAILS. Not available with corner configurations.
- ⁵ L8 and L12 only; 120-277V only. Not available with fixtures less than 4'.
- ⁶ L15 only; 120-277V only. Must be remote mounted for fixtures less than 4'.
- ⁷ Utilizes 4" of housing at end of fixture. See page 3 for FIXTURE DETAILS. 120V or 277V only.
- ⁸ See page 2 for ADDITIONAL DRIVER OPTIONS.
- ⁹ Not available with EM drivers.



MX4S LED

4" Continuous – Surface

FIXTURE PERFORMANCE DATA

	PER FOOT		
	DELIVERED LUMENS	WATTAGE	EFFICACY (lm/W)
L8	824	7.3	113
L12	1175	10.8	108
L15	1439	13.5	107

- Photometrics tested in accordance with IESNA LM-79. Results shown are based on 25°C ambient temperature.
- Wattage shown is average for 120V through 277V input.
- Results based on F shielding, 3500K, 80 CRI, actual lumens may vary +/-5%
- Use multiplier table to calculate additional options.

MULTIPLIER TABLE

	COLOR TEMPERATURE	
	CCT	CONVERSION FACTOR
80 CRI	2700K	0.97
	3000K	0.99
	3500K	1.00
	4000K	1.03
	5000K	1.06
90 CRI	2700K	0.82
	3000K	0.83
	3500K	0.84
	4000K	0.86
	5000K	0.90

PHOTOMETRY

MX4S-4'00-L8/835-F-DIM Total Luminaire Output: 3296 lumens; 29.2 Watts | Efficacy: 113 lm/W | 80 CRI; 3500K CCT

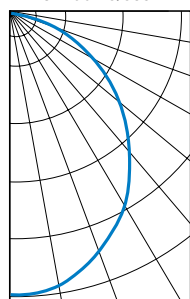

VERTICAL ANGLE	HORIZONTAL ANGLE			ZONAL LUMENS
	0°	45°	90°	
0	894	894	894	
5	913	887	878	123
15	882	846	832	348
25	789	764	746	512
35	684	651	639	597
45	555	530	510	597
55	415	395	371	513
65	270	254	243	368
75	127	122	121	192
85	20	25	23	45
90	0	0	0	

LUMEN SUMMARY	ZONE	LUMENS	% FIXTURE
	0 - 30	983	30
0 - 40	1580	48	
0 - 60	2690	82	
0 - 90	3296	100	
0 - 180	3296	100	

ADDITIONAL DRIVER OPTIONS

Note: Lumen restrictions apply, consult product builder at hew.com/product-builder.

CATALOG NUMBER	DESCRIPTION
DRV	Driver prewired for non-dimming applications
DIM	Dimming driver prewired for 0-10V low voltage applications
DIM1	1% dimming driver prewired for 0-10V low voltage applications
DIM LINE	Line voltage dimming driver (Must specify 120V or 277V only)
SD40	40% step-dimming driver
SD50	50% step-dimming driver
DALI	DALI dimming driver
LTE LINE	Lutron Hi-lume® A-Series 1% dimming driver for forward phase line voltage controls (120V only)
LDE1	Lutron EcoSystem® H-Series 1% dimming driver for EcoSystem® controls
LDE5	Lutron EcoSystem® 5-Series 5% dimming driver for EcoSystem® controls
ELDO SOLOB	EldoLED Solodrive, 0.1% dimming driver for 0-10V controls
ELDO SOLOB DALI	EldoLED Solodrive, 0.1% dimming driver for DALI controls
ELDO ECO1	EldoLED Ecodrive, 1% dimming driver for 0-10V controls
ELDO ECO1 DALI	EldoLED Ecodrive, 1% dimming driver for DALI controls



MX4S LED

4" Continuous – Surface

FIXTURE DETAILS

BACK VIEW

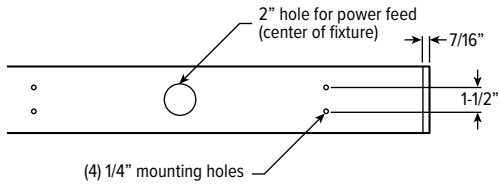

OCCUPANCY SENSOR



SHIELDING DETAILS

FLAT

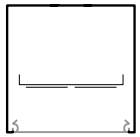

PROUD

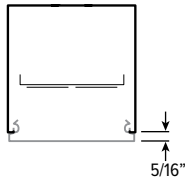

FINISH OPTIONS

WHITE

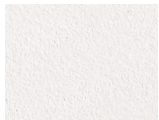

BLACK

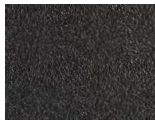

BRONZE

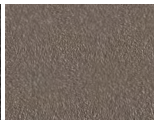

NICKEL

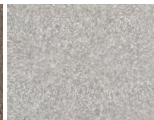

SILVER



ALUMINUM

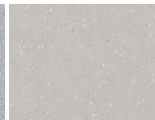

For custom color, please specify RAL code or a manufacturer code with description. All custom colors other than RAL require two sample swatches, minimum 1" square.

CORNER DETAILS

BACK VIEW

LEFT

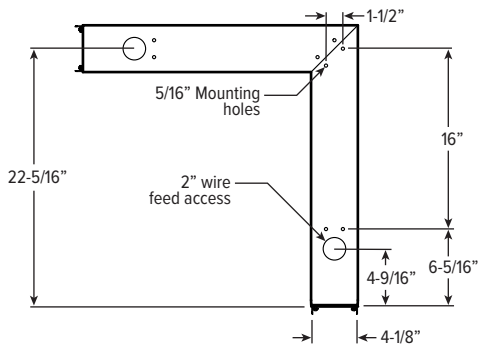

Note: Corner orientation determined in field. Feeder corner end cap shipped separately.

