

MX4RW tunable WHITE

4" Continuous – Recessed Shallow Wall or Hard Surface

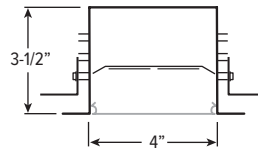

CATALOG #: _____

TYPE: _____

PROJECT: _____

FEATURES

- Tunable white from 3000K to 5000K CCT, minimum 80 CRI
- Create elegant spaces with a seamless, continuous row of illumination
- Designed for 3-1/2" shallow drywall or hard surface frames
- Flat and regressed lenses give designers a variety of looks
- Maximize energy savings with efficacies as high as 130 lm/W
- Versatile MX4 system includes recessed, surface, suspended and in-wall mounting, see hew.com
- Diffuse acrylic lens provides uniform illumination for visual comfort
- Made Right Here™ in the USA

SPECIFICATIONS

- HOUSING – Extruded aluminum.
- SHIELDING – Extruded, flat, diffuse acrylic lens.
- FINISH – 92% minimum average reflective white polyester powder coat bonded to phosphate-free, multi-stage pretreated metal. All parts painted after fabrication to facilitate installation, increase efficiency, and inhibit corrosion.
- ELECTRICAL – High quality mid-power LED board. L70 > 60,000 hours per IES TM-21. Tunable White products use LEDs of multiple CCTs and may produce a perceptibly different shade of white from single-CCT products at the same CCT. All CCTs are within 3 MacAdam ellipses.
- MOUNTING – Drywall mount allowing for materials 1/4" - 2" thick. Fixture to be installed prior to drywall or finished hard surface material.
- LISTINGS – cETLus conforms to UL STD 1598. Certified to CAN/CSA STD C22.2 No. 250.0. Suitable for damp locations.
- WARRANTY – 5-year limited warranty, see hew.com/warranty.

ORDERING EXAMPLE: MX4RWTR - 8'00 - L8/8TW - F - OPTIONS - DALI - UNV

SERIES	FIXTURE STYLE	LENGTH	LUMENS ^[1]	COLOR
MX4RW	TR Drywall or Hard Surface - Trim	Lengths specified in feet and inches using 4" increments, 2' minimum. Example: 8'00 = 8'-0"	L8 800lm	8TW Tunable white (80 CRI, 3000K-5000K)
	TL Drywall or Hard Surface - Trimless			

PRODUCT BUILDER
Simplify ordering & layout design with the Williams Linear Product Builder at hew.com/product-builder

SHIELDING	OPTIONS ^[2]	CONTROL ^[3]	VOLTAGE
F Flat, diffuse acrylic	EM/10W 10-watt emergency battery ^[5]	DALI Driver prewired for DALI applications	120 120V
R Regressed diffuse acrylic ^[4]	EM/10WRM Remote mount 10-watt emergency battery ^[6]	DIM (1) 0-10V signal to control dimming (1) 0-10V signal to control CCT	277 277V
	V90 Vertical 90° corner, suspended ^[7]	DMX Driver prewired for DMX applications	UNV 120-277V
	V90R Vertical 90° corner, recessed ^[8]		
	V90G Vertical 90° corner, grid ^[9]		

NOTES

- ¹ Lumens per foot output based on 4000 CCT and F shielding. Actual lumens per foot may vary +/-5%. See page 2 for FIXTURE PERFORMANCE DATA.
- ² See page 3 for FINISH OPTIONS. Custom colors available upon request. See Technical Info for [Power Entry](#) details.
- ³ See page 2 for CONTROL DETAILS.
- ⁴ See page 3 for SHIELDING DETAILS. Not available with transition options.
- ⁵ L8 only; 120-277V only. Not available with 2' fixtures.
- ⁶ L12 and L15 only; 120-277V only. Must be remote mounted for fixtures less than 4'.
- ⁷ Connects MX4D to vertically mounted MX4RW. See page 3 for FIXTURE DETAILS. Ships separately.
- ⁸ Transitions MX4RT to vertically mounted MX4RW. See page 3 for FIXTURE DETAILS. Ships separately.
- ⁹ Connects MX4RG to vertically mounted MX4RW. See page 3 for FIXTURE DETAILS. Ships separately.



MX4RW tunable WHITE 4" Continuous – Recessed Shallow Wall or Hard Surface

FIXTURE PERFORMANCE DATA

MX4RTL/MX4RTR: PER FOOT			
	DELIVERED LUMENS	WATTAGE	EFFICACY (lm/W)
L8	870	6.7	130

- Photometrics tested in accordance with IESNA LM-79. Results shown are based on 25°C ambient temperature.
- Wattage shown is average for 120V through 277V input.
- Results based on 4000K, 80 CRI, actual lumens may vary +/-5%
- Use multiplier table to calculate additional options.

MULTIPLIER TABLE

CONVERSION FACTOR		
CCT	LUMENS	WATTAGE
3000K	0.95	1.04
3500K	0.98	1.02
4000K	1.00	1.00
5000K	0.96	1.04

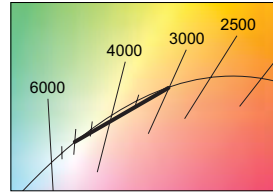

PHOTOMETRY

MX4RWTR-4'00-L8/8TW-F-DALI Total Luminaire Output: 3480 lumens; 26.8 Watts | Efficacy: 130 lm/W | 80 CRI; 3500K CCT

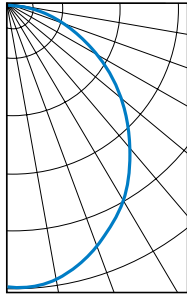

CANDLEPOWER DISTRIBUTION	VERTICAL ANGLE	HORIZONTAL ANGLE			ZONAL LUMENS
		0°	45°	90°	
	0	1424	1424	1424	
	5	1432	1406	1404	134
	15	1366	1332	1324	377
	25	1221	1201	1183	553
	35	1048	1016	998	640
	45	840	823	789	631
	55	631	594	584	537
	65	392	378	366	376
	75	179	177	179	190
	85	28	28	28	41
	90	2	0	0	

LUMEN SUMMARY	ZONE	LUMENS	% FIXTURE
	0 - 30	1064	31
	0 - 40	1704	49
	0 - 60	2873	83
	0 - 90	3480	100
	0 - 180	3480	100

CONTROL DETAILS

DIM



DALI



DMX



MX4RW tunable WHITE 4" Continuous – Recessed Shallow Wall or Hard Surface

FIXTURE DETAILS

BACK VIEW

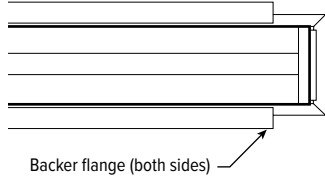

END VIEW

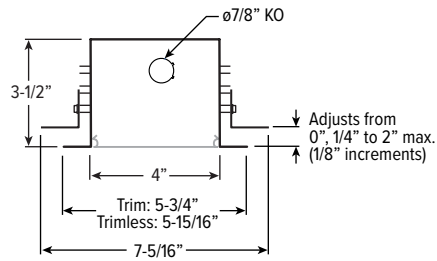

TRANSITION CORNERS

Includes tamper resistant lens bracket for lower end of vertical fixture.

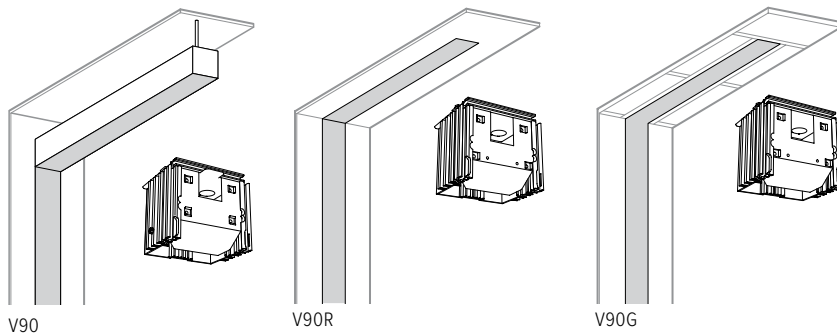

TRIM FINISH DETAILS

Trimless

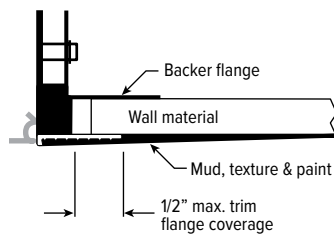

Trim

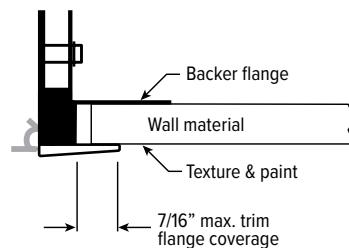

ROUGH-IN DIMENSIONS

- Framing allowance for width is 5-3/4" \pm 1/4".
- Framing allowance for length is total length plus 1-1/2" minimum.

SHIELDING DETAILS

FLAT

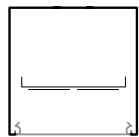

REGRESSED

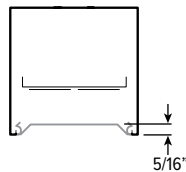

FINISH OPTIONS

WHITE

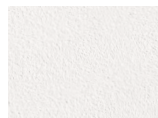

BLACK

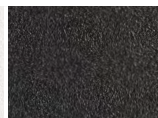

BRONZE

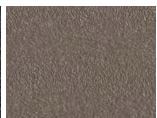

NICKEL

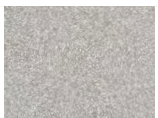

SILVER



ALUMINUM

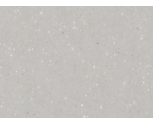

For custom color, please specify RAL code or a manufacturer code with description. All custom colors other than RAL require two sample swatches, minimum 1" square.

