

MX4WUD PoE | tunable WHITE 4" Continuous Up/Down – Wall

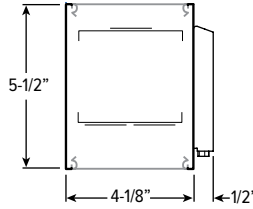
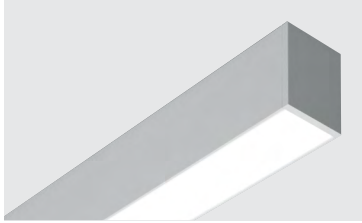

CATALOG #: _____

TYPE: _____

PROJECT: _____

FEATURES

- Williams turn-key Power over Ethernet (PoE) solution provides plug-and-play networked lighting and control
- Tunable white from 3000K to 5000K CCT, minimum 80 CRI
- Create elegant spaces with a seamless, continuous row of illumination
- Flat and proud lenses give designers a variety of looks
- Fixture attaches to wall bracket for simple installation
- Maximize energy savings with efficacies as high as 130 lm/W
- Linear extrusion contains snap-in light rails for ease of installation and maintenance
- Versatile MX4 system includes recessed, surface, suspended and in-wall mounting, see hew.com
- Diffuse acrylic lens provides uniform illumination for visual comfort
- Made Right Here™ in the USA

SYSTEM REQUIREMENTS

- Lighting system (site software)
- Gateway or alternate server (runs software)
- PoE switches or Ethernet switches and mid-span power injectors
- See hew.com/poe for details

SPECIFICATIONS

- HOUSING** – Extruded aluminum with die-cast end plates.
- SHIELDING** – Extruded, flat, diffuse acrylic lens.
- FINISH** – Textured matte white polyester TGIC powder coat bonded to phosphate-free, multi-stage pretreated metal. All parts painted after fabrication to facilitate installation, increase efficiency, and inhibit corrosion.
- ELECTRICAL** – High quality mid-power LED board. L70 > 60,000 hours per IES TM-21. Low-voltage DC fixture, to be fed by Class 2 power supply. Tunable White products use LEDs of multiple CCTs and may produce a perceptibly different shade of white from single-CCT products at the same CCT. All CCTs are within 3 MacAdam ellipses.
- MOUNTING** – Wall mount. Powder coated, die-formed C.R.S. receiving bracket mounted to fixture which attaches to galvanized, wall mounted bracket.
- LISTINGS** – cETLus conforms to UL STD 1598. Certified to CAN/CSA STD C22.2 No. 250.0. Suitable for damp locations.
- WARRANTY** – 5-year limited warranty, see hew.com/warranty.

ORDERING EXAMPLE: MX4WUD - 12'00 - P7/835U/P7/835D - A/F - OPTIONS - POE N

SERIES	LENGTH	LUMEN PACKAGE (EXAMPLE: P7/835U/P7/835D)			
MX4WUD	Lengths specified in feet and inches using 4" increments, 2' minimum. Example: 12'00 = 12'-0"	Specify lumen packages: U for Uplight and D for Downlight			
		LUMENS ^[1]	CRI	CCT	U or D
		P7 700lm	8 80	27 2700K	U Uplight
				30 3000K	D Downlight
				35 3500K	
		40 4000K			
		50 5000K			
		TW Tunable white (80 CRI, 3000K–5000K)			

SHIELDING UP	SHIELDING DOWN	OPTIONS ^[2]	CONTROL ^[3]
A Flat, semi-diffuse acrylic	F Flat, diffuse acrylic	EM/CP12 Remote mount 12-watt Iota emergency battery ^[6]	POE N Power over Ethernet network node
F Flat, diffuse acrylic ^[4]	P Proud, diffuse acrylic with 5/16" drop ^[5]		POE D Power over Ethernet device node ^[7]

NOTES

- Nominal lumens per foot output based on F shielding and 3500K for single CCT and 4000K for TW. Actual lumens may vary ±5%. See page 2 for FIXTURE PERFORMANCE DATA.
- See page 3 for FINISH OPTIONS. Custom colors available upon request. See hew.com/poe for compatible sensors and switches.
- For additional PoE info, see hew.com/poe.
- Recommended for use in applications where the fixture will be viewed from above. Decreases lumen output.
- See page 3 for SHIELDING DETAILS.
- Requires one additional category cable run to switch. See page 3 for REMOTE MOUNT DETAILS.
- Not available with fixtures over 40W.



MX4WUD PoE | tunable WHITE 4" Continuous Up/Down – Wall

FIXTURE PERFORMANCE DATA

STANDARD (PER FOOT)

	DELIVERED LUMENS	WATTAGE	EFFICACY (lm/W)
BT	1435	12	123

TUNABLE WHITE (PER FOOT)

	DELIVERED LUMENS	WATTAGE	EFFICACY (lm/W)
BT	1427	11	130

MULTIPLIER TABLES

STANDARD	
COLOR TEMPERATURE	
CCT	CONVERSION FACTOR
2700K	0.97
3000K	0.99
3500K	1.00
4000K	1.03
5000K	1.06

TUNABLE WHITE	
COLOR TEMPERATURE	
CCT	CONVERSION FACTOR
3000K	0.95
3500K	0.98
4000K	1.00
5000K	0.96

- Photometrics tested in accordance with IESNA LM-79. Results shown are based on 25°C ambient temperature.
- Standard results based on 3500K standard, 80 CRI, actual lumens may vary ±5%.
- Tunable white results based on 4000K standard, 80 CRI, actual lumens may vary ±5%.
- Use multiplier tables to calculate additional options.

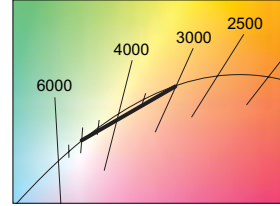

PHOTOMETRY

MX4WUD-4'00-P7/835U/P7/835D-A/F Total Luminaire Output: 5740 lumens; 46.8 Watts | Efficacy: 123 lm/W | 80 CRI; 3500K CCT

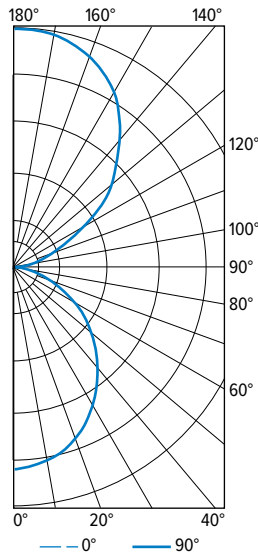

VERTICAL ANGLE	HORIZONTAL ANGLE					ZONAL LUMENS
	0°	45°	90°	135°	180°	
0	985	985	985	985	985	
5	1002	992	968	966	976	93
15	957	949	930	916	921	263
25	875	868	839	830	830	390
35	750	745	722	707	700	453
45	604	602	582	568	540	448
55	455	444	424	417	412	383
65	288	281	271	266	266	271
75	137	130	124	127	120	137
85	24	21	15	19	21	30
90	5	5	10	5	5	
95	50	58	60	53	48	61
105	172	185	187	168	148	189
115	341	364	381	336	307	350
125	558	576	594	544	508	506
135	799	808	810	772	734	607
145	980	983	990	945	925	606
155	1110	1113	1119	1082	1062	507
165	1177	1180	1192	1160	1146	331
175	1191	1196	1218	1185	1168	114
180	1192	1192	1192	1192	1192	

	ZONE	LUMENS	% FIXTURE
LUMEN SUMMARY	0 - 30	746	13
	0 - 40	1198	21
	0 - 60	2029	35
	0 - 90	2468	43
	90 - 120	601	11
	90 - 130	1107	19
	90 - 150	2320	40
	90 - 180	3272	57
	0 - 180	5740	100

MOUNTING DETAILS

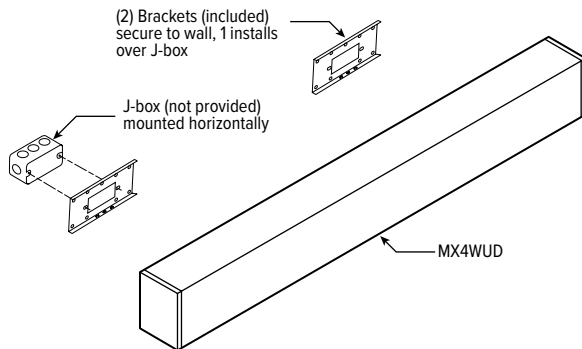

MX4WUD PoE | tunable **WHITE** 4" Continuous Up/Down – Wall

FIXTURE DETAILS

BACK VIEW

Standalone and feeder fixtures receive two mounting brackets. Joiner fixtures connect to feeder fixtures and receive one mounting bracket.

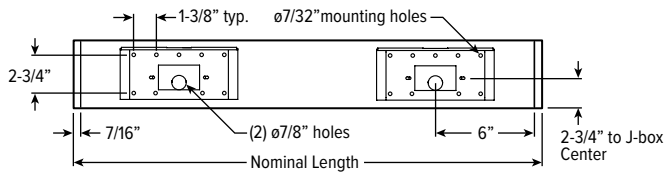

SHIELDING DETAILS

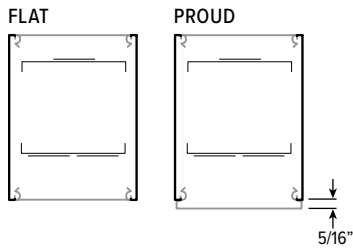

FINISH OPTION DETAILS

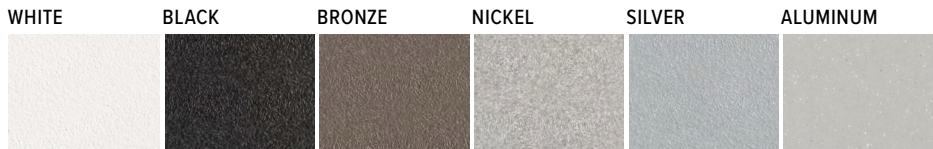

For custom color, please specify RAL code or a manufacturer code with description. All custom colors other than RAL require two sample swatches, minimum 1" square.

REMOTE MOUNT DETAILS

Includes 2' plenum-rated 18ga. solid cable. Remote box can be installed in:

- Above ceiling grid
- Remote closet (within 100ft)
- Surface below ceiling

