

MX4WUD tunable WHITE 4" Continuous Up/Down – Wall

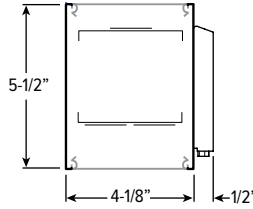
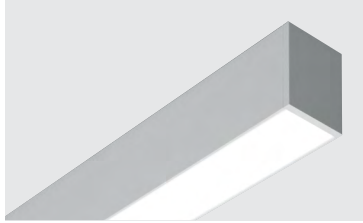

CATALOG #: _____

TYPE: _____

PROJECT: _____

FEATURES

- Tunable white from 3000K to 5000K CCT, minimum 80 CRI
- Create elegant spaces with a seamless, continuous row of illumination
- Flat and proud lenses give designers a variety of looks
- Fixture attaches to wall bracket for simple installation
- Maximize energy savings with efficacies as high as 124 lm/W
- Linear extrusion contains snap-in light rails for ease of installation and maintenance
- Versatile MX4 system includes recessed, surface, suspended and in-wall mounting, see hew.com
- Diffuse acrylic lens provides uniform illumination for visual comfort
- Made Right Here™ in the USA

SPECIFICATIONS

- HOUSING – Extruded aluminum with die-cast end plates.
- SHIELDING – Extruded, flat, diffuse acrylic lens.
- FINISH – Textured matte white polyester TGIC powder coat bonded to phosphate-free, multi-stage pretreated metal. All parts painted after fabrication to facilitate installation, increase efficiency, and inhibit corrosion.
- ELECTRICAL – High quality mid-power LED board. L70 > 60,000 hours per IES TM-21. Tunable White products use LEDs of multiple CCTs and may produce a perceptibly different shade of white from single-CCT products at the same CCT. All CCTs are within 3 MacAdam ellipses.
- MOUNTING – Wall mount. Powder coated, die-formed C.R.S. receiving bracket mounted to fixture which attaches to galvanized, wall mounted bracket.
- LISTINGS – cETLus conforms to UL STD 1598. Certified to CAN/CSA STD C22.2 No. 250.0. Suitable for damp locations.
- WARRANTY – 5-year limited warranty, see hew.com/warranty.

ORDERING EXAMPLE: MX4WUD - 12'00 - L8/8TWU/L8/8TWD - A/F - OPTIONS - DALI - UNV

SERIES	LENGTH	LUMEN PACKAGE (EXAMPLE: L8/8TWU/L8/8TWD)		
MX4WUD	Lengths specified in feet and inches using 4" increments, 2" minimum. Example: 12'00 = 12'-0"	Specify lumen packages: U for Uplight and D for Downlight		
		LUMENS ^[1]	COLOR	U or D
		L8 800lm	8TW Tunable white (80 CRI, 3000K-5000K)	U Uplight D Downlight
PRODUCT BUILDER Simplify ordering & layout design with the Williams Linear Product Builder at hew.com/product-builder				

SHIELDING UP	SHIELDING DOWN	OPTIONS ^[2]	CONTROL ^[3]	VOLTAGE
A Flat, semi-diffuse acrylic	F Flat, diffuse acrylic	EM/10WRM Remote mount 10-watt emergency battery ^[6]	DALI Driver prewired for DALI applications	120 120V 277 277V UNV 120-277V
F Flat, diffuse acrylic ^[4]	P Proud, diffuse acrylic with 5/16" drop ^[5]	OCC__ Factory-installed occupancy sensor ^[7] : OCCWS FS-355-L6	DIM (1) 0-10V signal to control dimming (1) 0-10V signal to control CCT	
			DMX Driver prewired for DMX applications	

NOTES

- ¹ Lumens per foot based on 4000K CCT and F shielding. Actual lumens may vary ±5%. See page 2 for FIXTURE PERFORMANCE DATA.
- ² See page 3 for FINISH OPTIONS. Custom colors available upon request.
- ³ See page 2 for CONTROL DETAILS.
- ⁴ Recommended for use in applications where the fixture will be viewed from above. Decreases lumen output.
- ⁵ See page 3 for SHIELDING DETAILS.
- ⁶ 120-277V only.
- ⁷ Recommended for use in downlight orientation only. Utilizes 4" of housing at end of fixture. See page 3 for FIXTURE DETAILS. 120V or 277V only.



MX4WUD tunable WHITE 4" Continuous Up/Down – Wall

FIXTURE PERFORMANCE DATA

L8	PER FOOT		
	DELIVERED LUMENS	WATTAGE	EFFICACY (lm/W)
	1667	13.4	124

- Photometrics tested in accordance with IESNA LM-79. Results shown are based on 25°C ambient temperature.
- Wattage shown is average for 120V through 277V input.
- Results based on 4000K, 80 CRI, actual lumens may vary +/-5%
- Use multiplier table to calculate additional options.

MULTIPLIER TABLE

CCT	CONVERSION FACTOR	
	LUMENS	WATTAGE
3000K	0.95	1.04
3500K	0.98	1.02
4000K	1.00	1.00
5000K	0.96	1.04

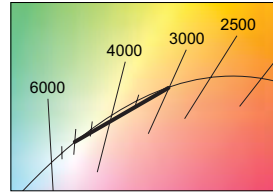

PHOTOMETRY

MX4WUD-4'00-L8/8TWU/L8/8TWD-A/F-DALI Total Luminaire Output: 6668 lumens; 53.7 Watts | Efficacy: 124 lm/W | 80 CRI; 3500K CCT

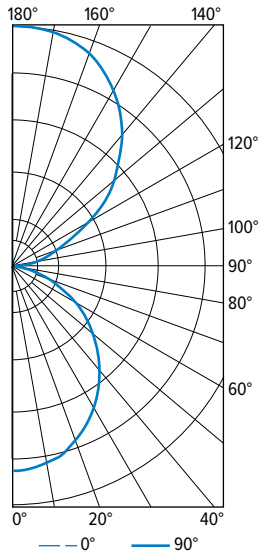

VERTICAL ANGLE	HORIZONTAL ANGLE					ZONAL LUMENS
	0°	45°	90°	135°	180°	
0	1144	1144	1144	1144	1144	
5	1164	1152	1124	1122	1134	108
15	1112	1102	1080	1064	1070	306
25	1016	1008	975	965	965	453
35	871	865	839	821	813	526
45	702	700	676	660	628	520
55	528	516	492	484	478	445
65	335	327	315	309	309	315
75	159	151	143	147	140	159
85	28	24	18	22	24	35
90	6	6	12	6	6	
95	58	68	70	62	56	71
105	199	215	217	195	171	220
115	397	422	442	391	357	407
125	648	670	690	632	590	588
135	929	939	941	897	853	705
145	1138	1142	1150	1098	1074	704
155	1289	1293	1299	1258	1234	589
165	1367	1371	1385	1347	1331	385
175	1383	1389	1415	1377	1357	132
180	1385	1385	1385	1385	1385	

LUMEN SUMMARY	ZONE	LUMENS	% FIXTURE
		0 - 30	866
	0 - 40	1392	21
	0 - 60	2358	35
	0 - 90	2867	43
	90 - 120	698	11
	90 - 130	1286	19
	90 - 150	2695	40
	90 - 180	3801	57
	0 - 180	6668	100

CONTROL DETAILS

DIM



DALI



DMX



MX4WUD tunable WHITE 4" Continuous Up/Down – Wall

MOUNTING DETAILS

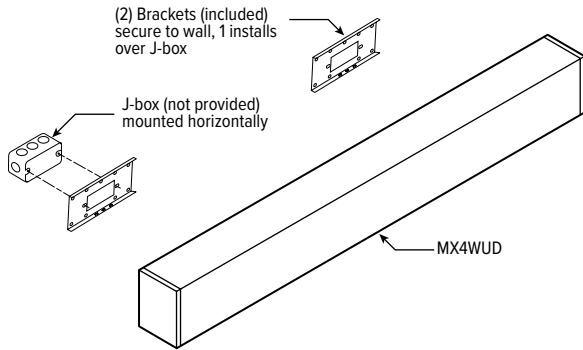

FIXTURE DETAILS

BACK VIEW

Standalone and feeder fixtures receive two mounting brackets. Joiner fixtures connect to feeder fixtures and receive one mounting bracket.

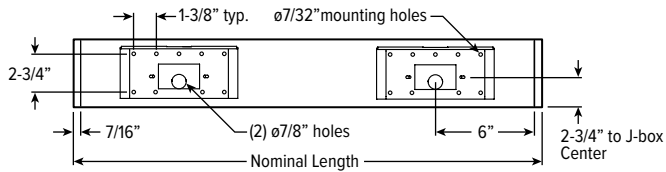

OCCUPANCY SENSOR



SHIELDING DETAILS

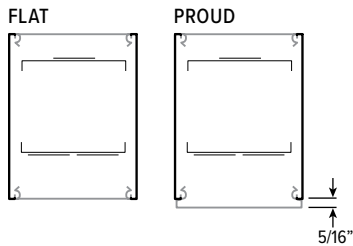

FINISH OPTIONS

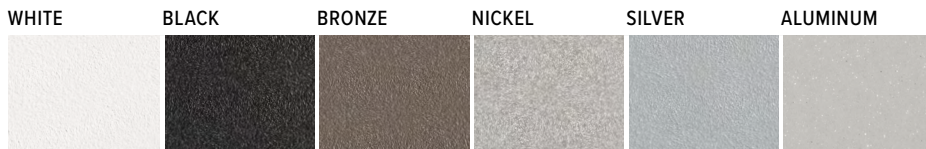

For custom color, please specify RAL code or a manufacturer code with description. All custom colors other than RAL require two sample swatches, minimum 1" square.