

# 8CRDI dim to WARM 8" Direct/Indirect Cylinder – Round

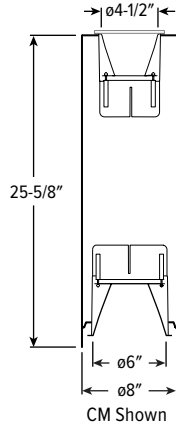

CATALOG #: \_\_\_\_\_

TYPE: \_\_\_\_\_

PROJECT: \_\_\_\_\_

## FEATURES

### TrimLock®

- High-output illumination for tall ceilings
- Smoothly accent walls and eliminate dark ceilings with direct and indirect lighting
- Create a comfortable, welcoming ambiance using warm dimming technology to provide intimate lighting
- Parallel the performance and style of the Williams downlight collection
- Precision illumination with 10° narrow to 65° wide optics
- Complement the architectural elements of any space with a multitude of housing, trim and cord finishes

## SPECIFICATIONS

- HOUSING** – Extruded aluminum with die-cast aluminum accent ring.
- FINISH** – Polyester powder coat bonded to phosphate-free, multi-stage pretreated metal. All parts painted after fabrication to facilitate installation, increase efficiency, and inhibit corrosion.
- TRIMLOCK** – Innovative TrimLock® reflector retention system ensures trim remains secure.
- OPEN REFLECTOR** – Low-iridescent anodized aluminum. Clear semi-specular finish standard.
- LENSED TRIM** – Die-cast aluminum frame with micro-prismatic, tempered glass lens.
- ELECTRICAL** – High-performance Class 2 C.O.B. LED array. Modular quick-connect plug for easy field-connection of LED light assembly to driver. Reported L70>55,000 hours. Reported L90>55,000 hours. Estimated L70 = 200,000 hours.
- MOUNTING** – Cable or wall mount. Indoor applications only. Max weight 20 lbs.
- LISTINGS** –
  - cCSAus conforms to UL STD 1598 and UL STD 8750. Certified to CAN/CSA STD C22.2 No. 250.0. Suitable for damp locations.
- WARRANTY** – 5-year limited warranty, see [hew.com/warranty](http://hew.com/warranty).

ORDERING EXAMPLE: 8CRDI - TL - L25/9DWU/L25/9DWD - OPTIONS - WHT - DIM - UNV - LW/LM - CS - TRIM OPTIONS - CM

## HOUSING

SERIES	LUMEN PACKAGE (Example: L25/9DWU/L15/9DWD)	OPTIONS	HOUSING FINISH	CONTROL	VOLTAGE
8CRDI - TL TrimLock	Specify lumen packages: <b>U</b> for Uplight and <b>D</b> for Downlight <b>LUMENS</b> <sup>[1]</sup> <b>COLOR</b> <b>U OR D</b>	<b>F</b> Fuse	<b>ALUM</b> Silver sparkle aluminum <b>BLK</b> Textured black <b>BRZ</b> Textured bronze <b>NKL</b> Textured nickel <b>SLV</b> Textured silver <b>WHT</b> Textured white	<b>DIM</b> Dimming driver, 0-10V <b>LUT</b> Lutron Ecosystem enabled	<b>UNV</b> 120-277V <b>347</b> 347V

## TRIM

TRIM TYPE AND DISTRIBUTION <sup>[2]</sup>  
(Example Uplight/Downlight: LW/LM)

TRIM TYPE	DISTRIBUTION
<b>Uplight</b>	<b>Uplight</b>
<b>O</b> Open reflector with clear glass shield <sup>[7]</sup>	<b>W</b> 65° Wide
<b>L</b> Flush lens <sup>[8]</sup>	<b>M</b> 35° Medium <sup>[9]</sup>
	<b>N</b> 10° Narrow <sup>[10]</sup>
<b>Downlight</b>	<b>Downlight</b>
<b>O</b> Open reflector	<b>W</b> 65° Wide
<b>L</b> Flush lens	<b>M</b> 35° Medium
<b>R</b> Regressed lens	<b>N</b> 10° Narrow

## REFLECTOR FINISH <sup>[3]</sup>

**Downlight Open Trim Types**

- CS** Clear semi-specular anodize
- SG** Satin-glow anodize
- GD** Gold anodize
- CG** Champagne gold anodize
- PW** Pewter anodize
- SPC** Clear specular anodize
- RG** Rose gold anodize
- WH** White texture powder coat
- BL** Black texture powder coat

## TRIM OPTIONS

**AD** Diffuse acrylic lens <sup>[4]</sup>

**PD** Diffuse 1/8" polycarbonate lens <sup>[5]</sup>

**TD** Diffuse polycarbonate lens media at top of open reflector <sup>[6]</sup>

## Downlight Lens Trim Types

- CS** Clear semi-specular powder coat
- WH** White texture powder coat
- BL** Black texture powder coat
- BZ** Bronze texture powder coat
- NK** Nickel texture powder coat
- SV** Silver texture powder coat
- AL** Silver sparkle aluminum

## MOUNTING

### MOUNTING TYPE <sup>[11]</sup>

**CM** Adjustable aircraft cable mount, 24" length standard. Example: 24" cable = **CM24** <sup>[12]</sup>

**WM** Wall mount

## NOTES

<sup>1</sup> Lumen output based on O trim type, W distribution and CS finish, 3000K/95CRI. Actual lumens may vary +/-5%, see page 2 for FIXTURE PERFORMANCE DATA

<sup>2</sup> Beam angle based on O Trim Type, WM Mounting Type and CS Reflector Finish. Trim Type affects beam angle. See page 2 for FIXTURE PERFORMANCE DATA.

<sup>3</sup> Specified for Downlight Trim Type only. See page 4 for REFLECTOR FINISH DETAILS.

<sup>4</sup> Not available with O trim type. Downlight only. W distribution only.

<sup>5</sup> Not available with O trim type. Downlight only. W distribution only.

<sup>6</sup> O Trim Type only. Downlight only.

<sup>7</sup> CS Reflector Finish standard. Other colors available, consult factory.

<sup>8</sup> Trim finish matches Housing Finish. Other colors available, consult factory.

<sup>9</sup> O Trim Type only.

<sup>10</sup> O Trim Type only.

<sup>11</sup> See page 4 for MOUNTING DETAILS.

<sup>12</sup> 48" and 96" lengths available. Canopy painted white unless specified otherwise. Must specify cord. See page 4 for CORD OPTIONS.



# 8CRDI dim to WARM

## 8" Direct/Indirect Cylinder – Round

### FIXTURE PERFORMANCE DATA

DIST.	WATTAGE	DOWNLIGHT						UPLIGHT WALL MOUNT				UPLIGHT CABLE MOUNT						
		OPEN REFLECTOR		FLUSH LENS		REGRESSED LENS		WATTAGE	OPEN REFLECTOR		FLUSH LENS		WATTAGE	OPEN REFLECTOR		FLUSH LENS		
		DELIVERED LUMENS	EFFICACY (lm/W)	DELIVERED LUMENS	EFFICACY (lm/W)	DELIVERED LUMENS	EFFICACY (lm/W)		DELIVERED LUMENS	EFFICACY (lm/W)	DELIVERED LUMENS	EFFICACY (lm/W)		DELIVERED LUMENS	EFFICACY (lm/W)	DELIVERED LUMENS	EFFICACY (lm/W)	
L8	W	14.0	887	63	739	53	716	51	14.0	808	58	733	52	14.0	731	52	568	41
	M	14.0	860	61	797	57	775	55	14.0	784	56	–	–	14.0	704	50	–	–
	N	14.0	823	59	802	57	781	56	14.0	750	54	–	–	14.0	678	48	–	–
L15	W	23.4	1554	66	1296	55	1254	54	23.4	1416	61	1285	55	23.4	1281	55	996	43
	M	23.4	1508	64	1397	60	1359	58	23.4	1374	59	–	–	23.4	1234	53	–	–
	N	23.4	1442	62	1405	60	1370	59	23.4	1314	56	–	–	23.4	1189	51	–	–
L25	W	37.7	2471	66	2123	56	2054	54	37.7	2252	60	2106	56	37.7	1889	50	1632	43
	M	37.7	2465	65	2284	61	2226	59	37.7	2246	60	–	–	37.7	1887	50	–	–
	N	37.7	2518	67	2302	61	2243	59	37.7	2295	61	–	–	37.7	1889	50	–	–

### MULTIPLIER TABLES

	REFLECTOR FINISH	
	CATALOG NUMBER	CONVERSION FACTOR
O TRIM	CS	1.00
	SG <sup>(1)</sup>	0.92
	GD	0.93
	CG	0.96
	PW	0.86
	SPC	1.02
	RG	0.88
	WH <sup>(1)</sup>	0.89
BL <sup>(1)</sup>	0.47	
R TRIM	WH	1.00
	CS <sup>(1)</sup>	0.98
	BL <sup>(1)</sup>	0.79
	BZ <sup>(1)</sup>	0.76
	NK <sup>(1)</sup>	0.81
	SV <sup>(1)</sup>	0.81
	AL <sup>(1)</sup>	0.86

TRIM OPTIONS	
CATALOG NUMBER	CONVERSION FACTOR
AD	0.85
PD	0.85
TD	0.75

### BEAM ANGLE

	TRIM TYPE						
	DOWNLIGHT			WM UPLIGHT		CM UPLIGHT	
	OPEN	FLUSH	REGRESSED	OPEN	FLUSH	OPEN	FLUSH
W	65°	55°	55°	65°	55°	65°	50°
M	35°	35°	35°	35°	35°	45°	35°
N	10°	25°	25°	10°	25°	10°	25°

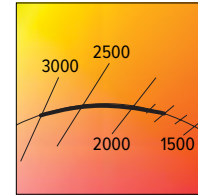

- Distribution will also be affected, consult factory.
  - 3000K CCT at 100% (full output) and 1800K CCT at 1% (full dim)
  - Photometrics tested in accordance with IESNA LM-79. Results shown are based on 25°C ambient temperature.
  - Wattage shown is based on 120V input.
  - Results based on 3000K/95CRI and CS (O Trim Type) or WH (L and R Trim Types) Reflector Finish. Actual lumens may vary +/-5%.
  - Wattage is for downlight or upright components. Add wattages together for selected lumen packages to find total fixture wattage.
  - Use multiplier tables to calculate additional options.

### PHOTOMETRY

8CRDI-TL-L25/9DWU/L25/9DWD-DIM-UNV-OW/OW-CS-WM Total Luminaire Output: 4857 lumens; 75.4 Watts | Efficacy: 64 lm/W | 95 CRI; 3000K CCT

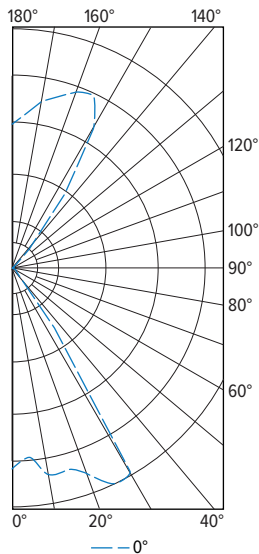

CANDLEPOWER DISTRIBUTION	VERTICAL ANGLE	HORIZONTAL ANGLE	ZONAL LUMENS
		0°	
	0	2078	
	5	1963	196
	15	2157	620
	25	2464	1113
	35	751	604
	45	57	48
	55	16	17
	65	2	3
	75	0	0
	85	0	1
	90	4	
	95	5	6
	105	8	8
	115	12	13
	125	26	24
	135	66	72
	145	939	576
	155	1970	878
	165	1827	522
	175	1598	158
	180	1482	

LUMEN SUMMARY	ZONE	LUMENS	% FIXTURE
	0 - 30	1929	40
	0 - 40	2533	52
	0 - 60	2597	54
	0 - 90	2601	54
	90 - 120	26	1
	90 - 150	699	14
	90 - 180	2256	47
	0 - 180	4857	100



# 8CRDI dim to WARM

## 8" Direct/Indirect Cylinder – Round

### DOWNLIGHT | UPLIGHT WALL MOUNT

### UPLIGHT CABLE MOUNT

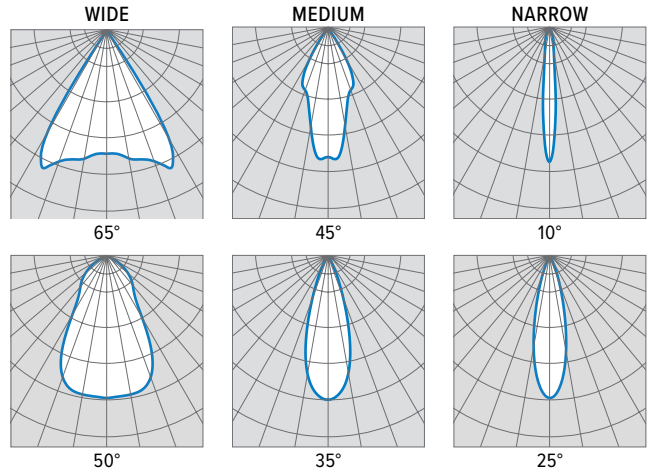
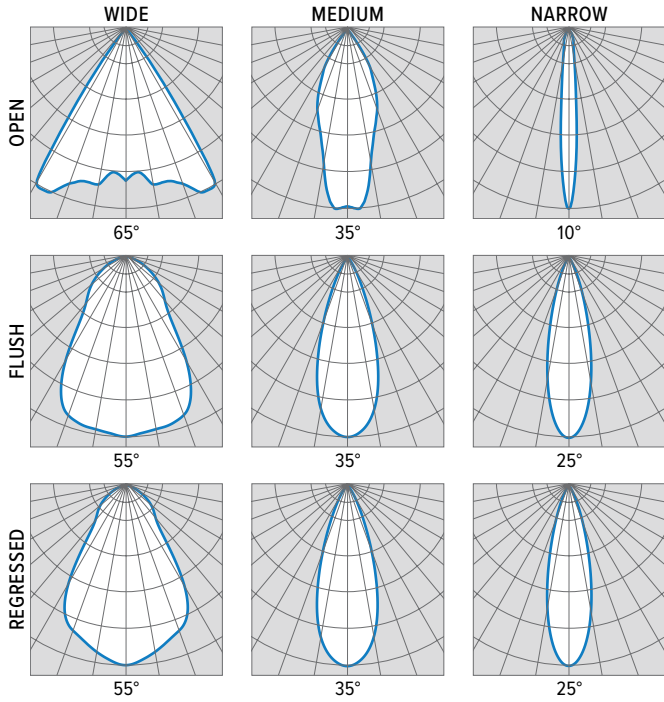

### TRIMLOCK DETAILS

#### TWIST



#### PULL



#### RELEASE



### CROSS SECTIONS

#### CM

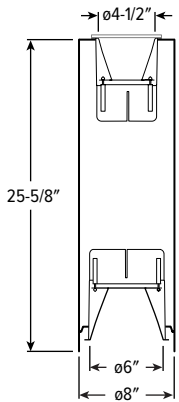

#### WM

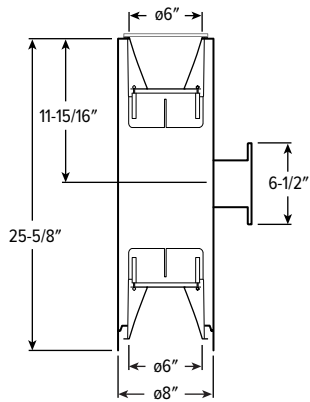

# 8CRDI dim to WARM

## 8" Direct/Indirect Cylinder – Round

### TRIM TYPE DETAILS

#### DOWNLIGHT

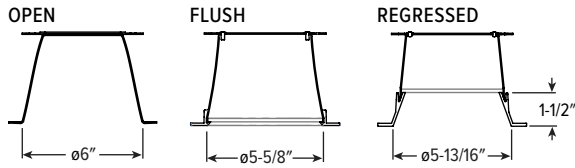

#### UPLIGHT WALL MOUNT

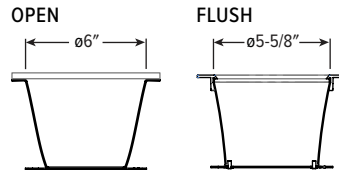

#### UPLIGHT CABLE MOUNT

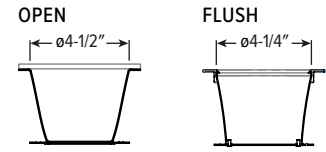

### MOUNTING DETAILS

#### CABLE MOUNT (CM\_)



Cable mount fixtures are provided with:

- Adjustable length aircraft cable, must specify length in inches
- 18-gauge cord in choice of 9 colors, see Cord Options for ordering info.
- One 5" canopy
- T-bar clip with 1/4-20 stud
- Hard ceiling anchor provided by others

#### WALL MOUNT (WM)



Mounts to 4" square J-box

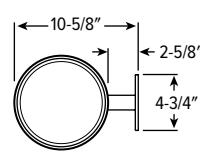

### CORD OPTIONS

Must specify cord when cable mounting.

ORDERING EXAMPLE: S2438/W				
CORD TYPE	LENGTH	# CONDUCTORS	WIRE SIZE	COLOR
S Straight	24 24"	3 3	8 18-gauge	Standard
	48 48"	4 4 <sup>(1)</sup>		/W White
	96 96"	5 5		/B Black
		6 6 <sup>(1)</sup>		Braided
				/WH White
				/BL Black
				/BR Brass
				/AE Aegean Blue
				/RE Red
				/SV Silver
				/GU Gunmetal
				/NK Nickle
				/GR Gray

<sup>1</sup> Standard cord only.

#### COLOR DETAILS

Additional colors may be available, consult factory.



### HOUSING FINISH DETAILS

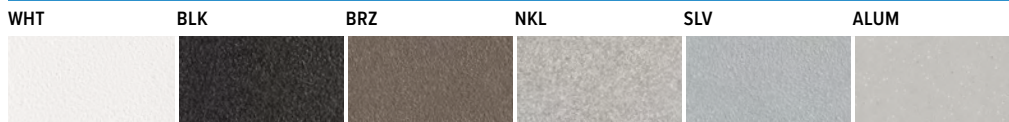

For custom color, please specify RAL code or a manufacturer code with description. All custom colors other than RAL require two sample swatches, minimum 1" square.

### REFLECTOR FINISH DETAILS

#### SMOOTH FINISH



#### TEXTURED FINISH

