

8CRDI LED 8" Direct/Indirect Cylinder – Round

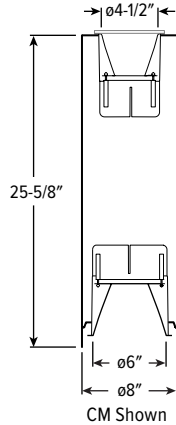

CATALOG #: _____

TYPE: _____

PROJECT: _____

FEATURES

TrimLock®

- High-output illumination for tall ceilings
- Smoothly accent walls and eliminate dark ceilings with direct and indirect lighting
- Parallel the performance and style of the Williams downlight collection
- Precision illumination with 10° narrow to 65° wide optics
- Complement the architectural elements of any space with a multitude of housing, trim and cord finishes

SPECIFICATIONS

- HOUSING** – Extruded aluminum with die-cast aluminum accent ring.
- FINISH** – Polyester powder coat bonded to phosphate-free, multi-stage pretreated metal. All parts painted after fabrication to facilitate installation, increase efficiency, and inhibit corrosion.
- TRIMLOCK** – Innovative TrimLock® reflector retention system ensures trim remains secure.
- OPEN REFLECTOR** – Low-iridescent anodized aluminum. Clear semi-specular finish standard.
- LENSED TRIM** – Die-cast aluminum frame with micro-prismatic, tempered glass lens.
- ELECTRICAL** – High-performance Class 2 C.O.B. LED array. Modular quick-connect plug for easy field-connection of LED light assembly to driver. Reported L70>55,000 hours. Reported L90>55,000 hours. Estimated L70 = 200,000 hours.
- MOUNTING** – Cable or wall mount. Indoor applications only. Max weight 20 lbs.
- LISTINGS** –
 - cCSAus conforms to UL STD 1598 and UL STD 8750. Certified to CAN/CSA STD C22.2 No. 250.0. Suitable for damp locations.
- WARRANTY** – 5-year limited warranty, see hew.com/warranty.

ORDERING EXAMPLE: 8CRDI - TL - L20/835U/L20/835D - OPTIONS - WHT - DIM - UNV - LW/LM - CS - TRIM OPTIONS - CM₁

HOUSING

SERIES	LUMEN PACKAGE (Example: L20/835U/L15/835D)	OPTIONS	HOUSING FINISH	CONTROL ^[1]	VOLTAGE
8CRDI - TL	Specify lumen packages: U for Uplight and D for Downlight	F Fuse	ALUM Silver sparkle aluminum	DIM Entire fixture switches and dims together ^[2]	UNV 120-277V
TrimLock	LUMENS ^[4] CRI CCT U OR D		BLK Textured black		347 347V ^[3]
	L10 1,000lm 8 80 27 2700K	U Uplight	BRZ Textured bronze		
	L15 1,500lm 9 90 ^[5] 30 3000K	D Downlight	NKL Textured nickel		
	L20 2,000lm 35 3500K		SLV Textured silver		
	L30 3,000lm 40 4000K		WHT Textured white		
	L40 4,000lm 50 5000K				
	L50 5,000lm				
	L60 6,000lm				
	L70 7,000lm				

TRIM

TRIM TYPE AND DISTRIBUTION ^[6]	REFLECTOR FINISH ^[7]	TRIM OPTIONS
(Example Uplight/Downlight: LW/LM)	Downlight Open Trim Types	AD Diffuse acrylic lens ^[8]
TRIM TYPE	CS Clear semi-specular anodize	PD Diffuse 1/8" polycarbonate lens ^[9]
DISTRIBUTION	SG Satin-glow anodize	TD Diffuse polycarbonate lens media at top of open reflector ^[10]
Uplight	GD Gold anodize	
O Open reflector with clear glass shield ^[11]	CG Champagne gold anodize	
L Flush lens ^[12]	PW Pewter anodize	
	SPC Clear specular anodize	
	RG Rose gold anodize	
Downlight	WH White texture powder coat	
O Open reflector	BL Black texture powder coat	
L Flush lens	Downlight Lens Trim Types	
R Regressed lens	CS Clear semi-specular powder coat	
	WH White texture powder coat	
	BL Black texture powder coat	
	BZ Bronze texture powder coat	
	NK Nickel texture powder coat	
	SV Silver texture powder coat	
	AL Silver sparkle aluminum	

MOUNTING

MOUNTING TYPE ^[17]
CM Adjustable aircraft cable mount, 24" length standard. Example: 24" cable = CM24 ^[18]
WM Wall mount

NOTES

- See page 4 for ADDITIONAL CONTROL OPTIONS.
- Requires 5 conductor cord.
- Not available with L70 lumen package.
- Lumen output based on O trim type, W distribution and CS finish. 3500K/80CRI. Actual lumens may vary +/-5%, see page 2 for FIXTURE PERFORMANCE DATA.
- Extended lead times may apply. Consult factory for availability.
- Beam angle based on O Trim Type, WM Mounting Type and CS Reflector Finish. Trim Type affects beam angle. See page 2 for FIXTURE PERFORMANCE DATA.
- Specified for Downlight Trim Type only. See page 5 for REFLECTOR FINISH DETAILS.
- Not available with O trim type. Downlight only. W distribution only.
- Not available with O trim type. Downlight only. W distribution only.
- O Trim Type only. Downlight only. L50 lumen package max.
- CS Reflector Finish standard. Other colors available, consult factory.
- Trim finish matches Housing Finish. Other colors available, consult factory.
- O Trim Type only.
- O Trim Type only.
- Not available with lumen stops L50 and higher when specified with L or R trim types.
- Not available with lumen stops L50 and higher when specified with L or R trim types.
- See page 5 for MOUNTING DETAILS.
- Uplight not available with L70 lumen package. 48" and 96" lengths available. Canopy painted white unless specified otherwise. Must specify cord. See page 5 for CORD OPTIONS.



8CRDI LED

8" Direct/Indirect Cylinder – Round

FIXTURE PERFORMANCE DATA

DIST.	WATTAGE	DOWNLIGHT						UPLIGHT WALL MOUNT					UPLIGHT CABLE MOUNT					
		OPEN REFLECTOR		FLUSH LENS		REGRESSED LENS		OPEN REFLECTOR		FLUSH LENS			OPEN REFLECTOR		FLUSH LENS			
		DELIVERED LUMENS	EFFICACY (lm/W)	DELIVERED LUMENS	EFFICACY (lm/W)	DELIVERED LUMENS	EFFICACY (lm/W)	DELIVERED LUMENS	EFFICACY (lm/W)	DELIVERED LUMENS	EFFICACY (lm/W)	DELIVERED LUMENS	EFFICACY (lm/W)	DELIVERED LUMENS	EFFICACY (lm/W)	DELIVERED LUMENS	EFFICACY (lm/W)	
L10	W	8.7	1014	117	674	77	660	76	8.6	924	107	772	90	9.0	871	97	681	79
	M	8.7	982	113	895	103	895	103	8.6	895	104	–	–	9.0	847	94	–	–
	N	8.7	1003	115	914	105	882	101	8.6	914	106	–	–	9.0	848	94	–	–
L15	W	13.8	1497	108	994	72	972	70	13.7	1364	100	1176	86	13.9	1243	89	1004	73
	M	13.8	1495	108	1319	96	1319	96	13.7	1362	99	–	–	13.9	1247	90	–	–
	N	13.8	1528	111	1347	98	1300	94	13.7	1392	102	–	–	13.9	1249	90	–	–
L20	W	19.1	1988	104	1352	71	1323	69	18.9	1812	96	1559	82	19.8	1700	86	1366	72
	M	19.1	1983	104	1794	94	1795	94	18.9	1807	96	–	–	19.8	1697	86	–	–
	N	19.1	2026	106	1833	96	1769	93	18.9	1846	98	–	–	19.8	1699	86	–	–
L30	W	26.9	3062	114	2022	75	1979	74	26.6	2790	105	2330	88	27.8	2531	91	2043	77
	M	26.9	3003	112	2683	100	2685	100	26.6	2736	103	–	–	27.8	2459	88	–	–
	N	26.9	3000	112	2741	102	2646	98	26.6	2734	103	–	–	27.8	2318	83	–	–
L40	W	36.5	4094	112	2695	74	2638	72	36.1	3731	103	3116	86	38.0	3373	89	2722	75
	M	36.5	4016	110	3577	98	3579	98	36.1	3660	101	–	–	38.0	3277	86	–	–
	N	36.5	4011	110	3654	100	3527	97	36.1	3655	101	–	–	38.0	3089	81	–	–
L50	W	43.9	5014	114	3364	77	3292	75	43.4	4569	105	3816	88	45.2	4344	96	3398	78
	M	43.9	4935	112	–	–	–	–	43.4	4497	104	–	–	45.2	4202	93	–	–
	N	43.9	5047	115	–	–	–	–	43.4	4599	106	–	–	45.2	4085	90	–	–
L60	W	54.0	6043	112	3827	71	3745	69	53.4	5507	103	4600	86	46.3	5220	113	4083	76
	M	54.0	5948	110	–	–	–	–	53.4	5420	101	–	–	46.3	5049	109	–	–
	N	54.0	6083	113	–	–	–	–	53.4	5543	104	–	–	46.3	4908	106	–	–
L70	W	55.9	6964	125	3364	60	3292	59	55.3	6386	115	5301	96	–	–	–	–	–
	M	55.9	6855	123	–	–	–	–	55.3	6286	114	–	–	–	–	–	–	–
	N	55.9	7011	125	–	–	–	–	55.3	6428	116	–	–	–	–	–	–	–

MULTIPLIER TABLES

	COLOR TEMPERATURE	
	CCT	CONVERSION FACTOR
80 CRI	2700K	0.92
	3000K	0.98
	3500K	1.00
	4000K	1.01
	5000K	1.02
90 CRI	2700K	0.76
	3000K	0.79
	3500K	0.82
	4000K	0.84
	5000K	0.88

	REFLECTOR FINISH	
	CATALOG NUMBER	CONVERSION FACTOR
O TRIM	CS	1.00
	SG ⁽¹⁾	0.92
	GD	0.93
	CG	0.96
	PW	0.86
	SPC	1.02
	RG	0.88
R TRIM	WH ⁽¹⁾	0.89
	BL ⁽¹⁾	0.47
	WH	1.00
	CS ⁽¹⁾	0.98
	BL ⁽¹⁾	0.79
BZ ⁽¹⁾	0.76	
NK ⁽¹⁾	0.81	
SV ⁽¹⁾	0.81	
AL ⁽¹⁾	0.86	

TRIM OPTIONS	
CATALOG NUMBER	CONVERSION FACTOR
AD	0.85
PD	0.85
TD	0.75

BEAM ANGLE

	TRIM TYPE							
	DOWNLIGHT			WM UPLIGHT		CM UPLIGHT		
	OPEN	FLUSH	REGRESSED	OPEN	FLUSH	OPEN	FLUSH	
W	65°	55°	55°	65°	55°	65°	50°	
M	35°	35°	35°	35°	35°	45°	35°	
N	10°	25°	25°	10°	25°	10°	25°	

- Distribution will also be affected, consult factory.
- Photometrics tested in accordance with IESNA LM-79. Results shown are based on 25°C ambient temperature.
- Wattage shown is based on 120V input.
- Results based on 3500K/80CRI and CS (O Trim Type) or WH (L and R Trim Types) Reflector Finish. Actual lumens may vary +/-5%.
- Wattage is for downlight or uplight components. Add wattages together for selected lumen packages to find total fixture wattage.
- Use multiplier tables to calculate additional options.



8CRDI LED 8" Direct/Indirect Cylinder – Round

PHOTOMETRY

8CRDI-TL-L20/835U/L20/835D-DIM-UNV-OW/OW-CS-WM Total Luminaire Output: 3919 lumens; 36.9 Watts | Efficacy: 106 lm/W | 80 CRI; 3500K CCT

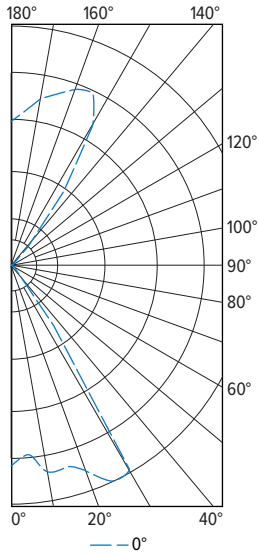

VERTICAL ANGLE	HORIZONTAL ANGLE	ZONAL LUMENS
	0°	
0	1672	
5	1579	158
15	1735	498
25	1982	895
35	604	490
45	46	39
55	13	13
65	2	3
75	0	0
85	0	1
90	4	
95	4	5
105	6	7
115	10	10
125	21	20
135	53	67
145	755	469
155	1585	699
165	1470	420
175	1285	126
180	1193	

LUMEN SUMMARY	ZONE	LUMENS	% FIXTURE
	0 - 30	1551	40
0 - 40	2041	52	
0 - 60	2093	53	
0 - 90	2097	54	
90 - 120	21	1	
90 - 150	578	15	
90 - 180	1822	47	
0 - 180	3919	100	

DOWNLIGHT | UPLIGHT WALL MOUNT

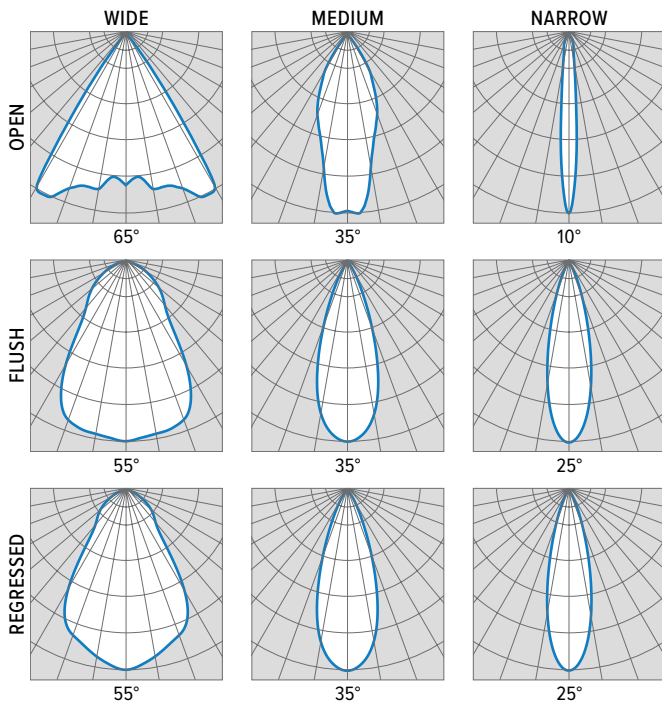

UPLIGHT CABLE MOUNT

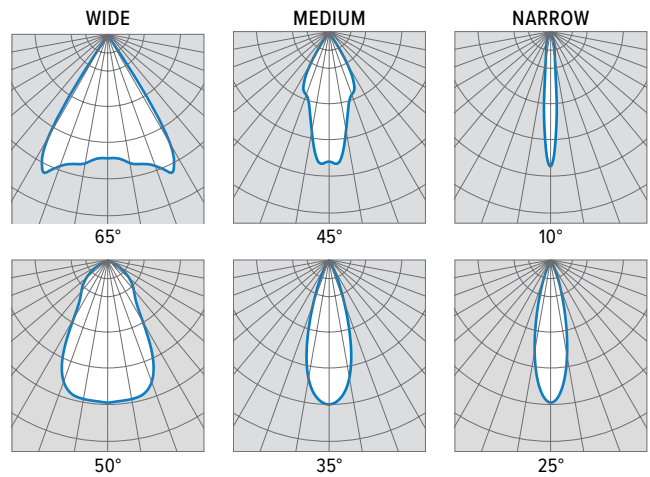

8CRDI LED

8" Direct/Indirect Cylinder – Round

ADDITIONAL CONTROL OPTIONS

Lumen restrictions apply: L40 max for Lutron drivers, L60 max for ELDO drivers, L60 max for DIM LINE driver. 347V only available with DIM and DIM1 drivers.

CATALOG NUMBER	DESCRIPTION
DIM	Dimming driver prewired for 0-10V low voltage applications; entire fixture switches and dims together
DIMU/DIMD	Dimming driver prewired for 0-10V low voltage applications; up and down portions switch and dim separately
DIM1	1% dimming driver prewired for 0-10V low voltage applications
DIM1U/DIM1D	1% dimming driver prewired for 0-10V low voltage applications; up and down portions switch separately
DIM LINE	Line voltage dimming driver (TRIAC and ELV compatible, 120V only)
DIM LINEU/DIM LINED	Line voltage switching and line voltage dimming; up and down portions switch separately
LTE LINE	Lutron Hi-lume 1% 2-wire dimming driver forward phase line voltage controls (120V only)
LDE1	Lutron Hi-lume 1% EcoSystem dimming LED driver
LDE1/LDE1	Lutron Hi-lume 1% EcoSystem dimming LED driver; up and down portions switch separately
ELDO SOLOB	EldoLED Solodrive, 0.1% dimming driver for 0-10V controls
ELDO SOLOB/ELDO SOLOB	EldoLED Solodrive, 0.1% dimming driver for 0-10V controls; up and down portions switch separately
ELDO SOLOB DALI	EldoLED Solodrive, 0.1% dimming driver for DALI controls
ELDO SOLOB DALI/ ELDO SOLOB DALI	EldoLED Solodrive, 0.1% dimming driver for DALI controls; up and down portions switch separately
ELDO ECO1	EldoLED Ecodrive, 1% dimming driver for 0-10V controls
ELDO ECO1/ELDO ECO1	EldoLED Ecodrive, 1% dimming driver for 0-10V controls; up and down portions switch separately
ELDO ECO1 DALI	EldoLED Ecodrive, 1% dimming driver for DALI controls
ELDO ECO1 DALI/ELDO ECO1 DALI	EldoLED Ecodrive, 1% dimming driver for DALI controls; up and down portions switch separately

TRIMLOCK DETAILS

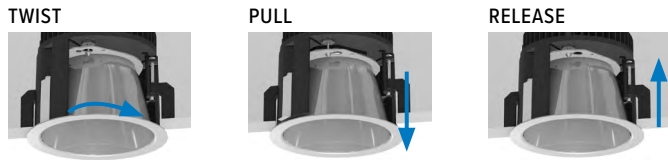

CROSS SECTIONS

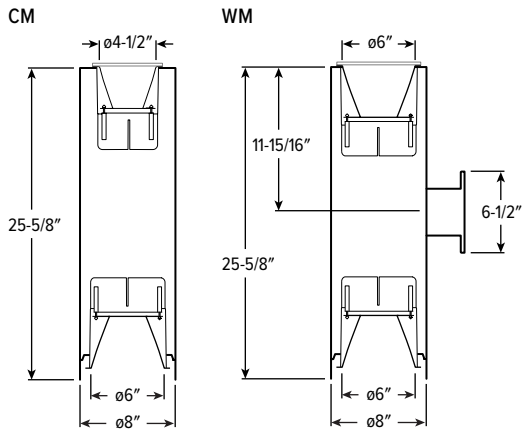

TRIM TYPE DETAILS

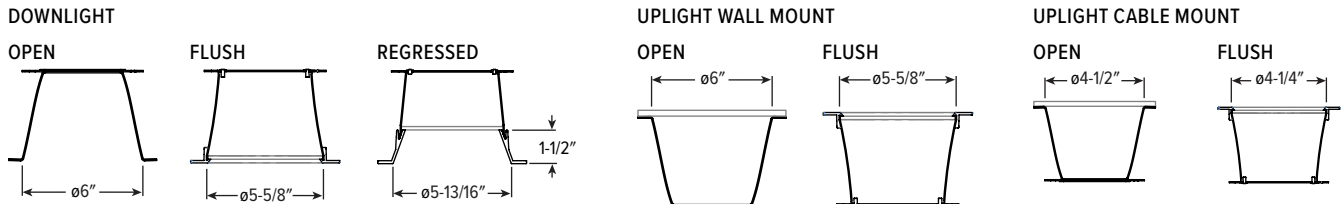

8CRDI LED 8" Direct/Indirect Cylinder – Round

MOUNTING DETAILS

CABLE MOUNT (CM__)



Cable mount fixtures are provided with:

- Adjustable length aircraft cable, must specify length in inches
- 18-gauge cord in choice of 9 colors, see Cord Options for ordering info.
- One 5" canopy
- T-bar clip with 1/4-20 stud
- Hard ceiling anchor provided by others

WALL MOUNT (WM)



Mounts to 4" square J-box

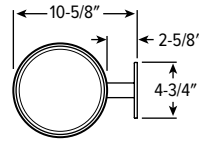

CORD OPTIONS

Must specify cord when cable mounting.

ORDERING EXAMPLE: S2438/W				
CORD TYPE	LENGTH	# CONDUCTORS	WIRE SIZE	COLOR
S Straight	24 24"	3 3	8 18-gauge	Standard
	48 48"	4 4 ⁽¹⁾		/W White
	96 96"	5 5		/B Black
		6 6 ⁽¹⁾		Braided
				/WH White
				/BL Black
			/BR Brass	
			/AE Aegean Blue	
			/RE Red	
			/SV Silver	
			/GU Gunmetal	
			/NK Nickel	
			/GR Gray	

¹ Standard cord only.

COLOR DETAILS

Additional colors may be available, consult factory.



HOUSING FINISH DETAILS

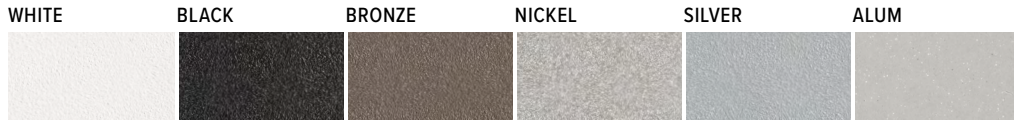

For custom color, please specify RAL code or a manufacturer code with description. All custom colors other than RAL require two sample swatches, minimum 1" square.

REFLECTOR FINISH DETAILS

SMOOTH FINISH

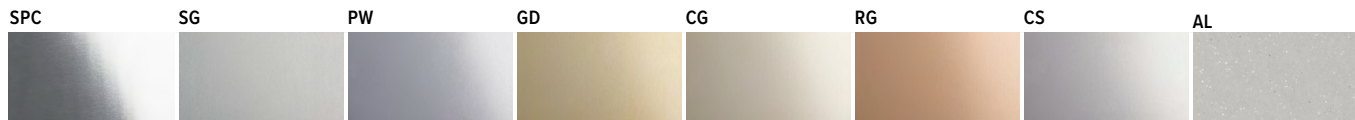

TEXTURED FINISH

