

M6PR dim to WARM

6" MRI Shallow Plenum Downlight – Round

FIXTURE PERFORMANCE DATA

	DISTRIBUTION	DELIVERED LUMENS	CCT AT 100% (FULL OUTPUT)	CCT AT 1% (FULL DIM)	WATTAGE	EFFICACY (lm/W)
L8	W	806	3000K	1800K	14.0	57.6
	M	817			14.0	58.4
	N	825			14.0	58.9
L14	W	1413			23.4	60.4
	M	1433			23.4	61.2
	N	1446			23.4	61.8
L23	W	2314			37.7	61.4
	M	2347			37.7	62.3
	N	2369			37.7	62.8

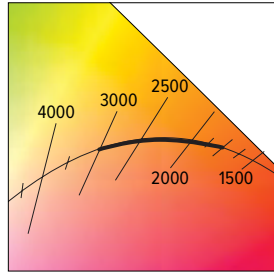

MULTIPLIER TABLE

TRIM	
CATALOG NUMBER	CONVERSION FACTOR
AD	0.85
PD	0.85

- Photometrics tested in accordance with IESNA LM-79. Results shown are based on 25°C ambient temperature.
- Wattage shown is based on 120V input.
- Results based on 3000K, 95 CRI, full output, actual lumens may vary +/-5%
- Use multiplier table to calculate additional options.

PHOTOMETRY

M6PR-L23/9DW-DIM-UNV-LW-OF-WH Total Luminaire Output: 2314 lumens; 37.7 Watts | Efficacy: 61.4 lm/W | 95.0 CRI; 3000K CCT

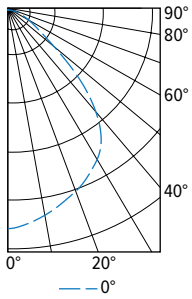

CANDLEPOWER DISTRIBUTION	VERTICAL ANGLE	HORIZONTAL ANGLE	ZONAL LUMENS
		0°	
	0	1225	
	5	1203	114
	15	1127	318
	25	1036	477
	35	901	557
	45	582	442
	55	233	218
	65	116	117
	75	53	57
	85	12	15
	90	1	

LUMEN SUMMARY	ZONE	LUMENS	% FIXTURE
	0 - 40	1466	63
	0 - 60	2126	92
	0 - 90	2314	100
	0 - 180	2314	100

M6PR-L23/9DW-DIM-UNV-LM-OF-WH Total Luminaire Output: 2347 lumens; 37.7 Watts | Efficacy: 62.3 lm/W | 95.0 CRI; 3000K CCT

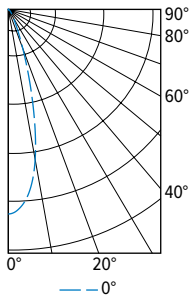

CANDLEPOWER DISTRIBUTION	VERTICAL ANGLE	HORIZONTAL ANGLE	ZONAL LUMENS
		0°	
	0	5398	
	5	5188	476
	15	3397	913
	25	1074	512
	35	319	209
	45	140	110
	55	73	66
	65	37	37
	75	18	19
	85	3	4
	90	0	

LUMEN SUMMARY	ZONE	LUMENS	% FIXTURE
	0 - 40	2110	90
	0 - 60	2286	97
	0 - 90	2347	100
	0 - 180	2347	100

M6PR-L23/9DW-DIM-UNV-LN-OF-WH Total Luminaire Output: 2369 lumens; 37.7 Watts | Efficacy: 62.8 lm/W | 95.0 CRI; 3000K CCT

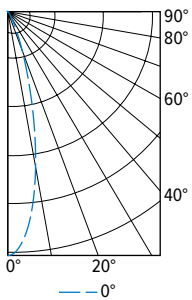

CANDLEPOWER DISTRIBUTION	VERTICAL ANGLE	HORIZONTAL ANGLE	ZONAL LUMENS
		0°	
	0	8749	
	5	7909	686
	15	3390	933
	25	808	392
	35	223	147
	45	112	88
	55	69	62
	65	38	38
	75	17	18
	85	3	4
	90	0	

LUMEN SUMMARY	ZONE	LUMENS	% FIXTURE
	0 - 40	2159	91
	0 - 60	2308	97
	0 - 90	2369	100
	0 - 180	2369	100



M6PR dim to **WARM** 6" MRI Shallow Plenum Downlight – Round

TRIMLOCK DETAILS



FLANGE TYPE DETAILS

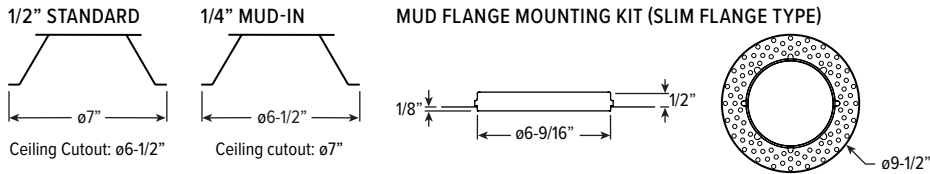

REFLECTOR FINISH DETAILS

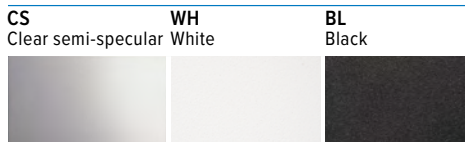

MOUNTING TYPE DETAILS

NEW CONSTRUCTION

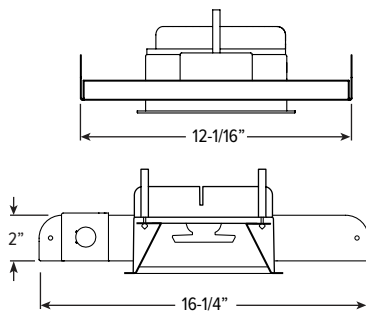

IC-RATED

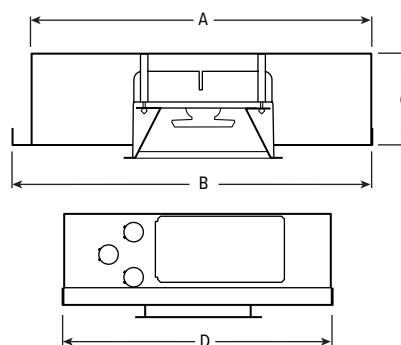

LUMENS	LENGTH			
	A	B	C	D
L8	15-3/16"	16"	4-1/8"	12-1/8"
L14	15-3/16"	16"	5-7/8"	12-1/8"

MOUNTING HARDWARE DETAILS

F1M Factory-installed 2-position fixed pan bracket, universal bar hanger included

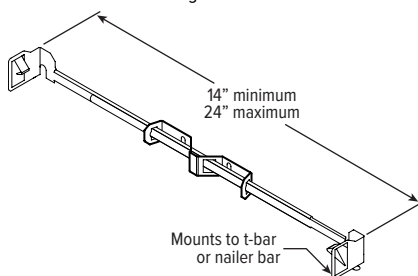

BA1M Adjustable butterfly pan bracket, aluminum, bar hanger not included (N Mounting Type only)

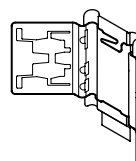

CA1M Adjustable caterpillar pan bracket, aluminum, universal bar hanger included (N Mounting Type only)

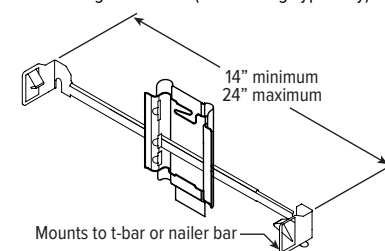

M6PR dim to WARM 6" MRI Shallow Plenum Downlight – Round

REMOTE DRIVER ENCLOSURE DETAILS (ORDERED & SHIPPED SEPARATELY)

REMOTE DRIVER ENCLOSURE FOR SINGLE FIXTURE

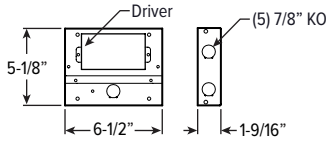

REMOTE DRIVER ENCLOSURE FOR SINGLE FIXTURE WITH EM/12W

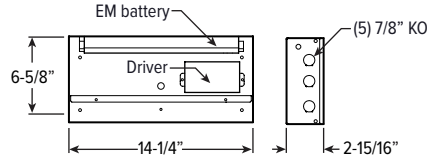

REMOTE DRIVER ENCLOSURE FOR 2 - 8 FIXTURES

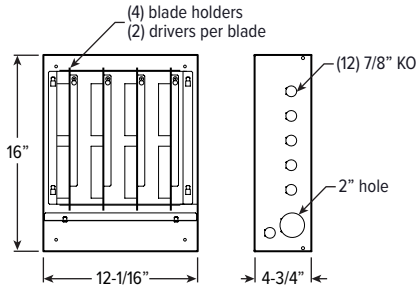

REMOTE DRIVER ENCLOSURE FOR 9 - 12 FIXTURES

