

# DUAL-FUNCTION MEDICAL BED LIGHT

# MD4

tunable **WHITE** | PoE



CATALOG #:	TYPE:
PROJECT:	NOTES:

**EXAMPLE** MD 4+4AE G - 4 - P30/P80/840 - A - OPTIONS - POEN

SERIES	STYLE	CEILING TYPE	NOMINAL LENGTH	LUMEN PACKAGE	CRI & CCT	SHIELDING	OPTIONS/ACCESSORIES	CONTROL
--------	-------	--------------	----------------	---------------	-----------	-----------	---------------------	---------

## CROSS SECTION

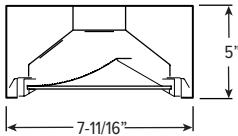

## ORDERING INFORMATION

**SERIES**  
**MD** Dual-Function Medical Bed Light – PoE

**STYLE**  
See table below.

**CEILING TYPE**  
When using in NEMA Type “SG” or “NFG” applications, must specify EQCLIPS option.  
For flange installations use the Drywall Kit (DFK), see Accessories.  
**G** NEMA Type “G”, “SG”, and “NFG”

**NOMINAL LENGTH**  
4 4'

**LUMEN PACKAGE**  
See table below for lumen packages.

**CRI & CCT**

<b>827</b>	82 CRI, 2700K
<b>830</b>	82 CRI, 3000K
<b>835</b>	82 CRI, 3500K
<b>840</b>	82 CRI, 4000K
<b>850</b>	82 CRI, 5000K
<b>940</b>	90 CRI, 4000K
<b>950</b>	90 CRI, 5000K
<b>BTW</b>	Tunable white (80 CRI, 3000K–5000K) for Ambient section only (Exam portion 840, additional color temperatures available, see options).

**SHIELDING**  
**A** Curved diffuse ribbed acrylic with clear, acrylic lens

**OPTIONS**  
**EM/CP12** Remote mount 12-watt Iota emergency LED battery, controls ambient compartment only (requires one additional category cable run to switch, see page 3 for details)

**BC** Fixture prewired for bedside controls, button functionality determined with gateway software.

**TG** Triple gasket (field installed)  
**(8\_\_\_)** Color temperature in Exam compartment different than Ambient. Must specify color temperature (30, 35 or 50).  
**Example:** MD4+4AEG-4-P30/P80/840-A-(835)

**EQCLIPS** Earthquake clips (2 per fixture)

**ACCESSORIES** (Must be ordered separately)  
See [hew.com/poe](http://hew.com/poe) for compatible sensors & switches  
Fixture must be installed prior to Drywall Kit (DFK).  
**DFK-0848AMW** Drywall kit, 8” x 48”, anti-microbial white

**CONTROL**  
For additional PoE info, see [hew.com/poe](http://hew.com/poe)  
**POE N** Power over Ethernet network node  
**POE D** Power over Ethernet device node

## FEATURES

- ▶ Williams turn-key Power over Ethernet (PoE) solution provides plug-and-play networked lighting and control.
- ▶ Tunable white from 3000K to 5000K CCT, minimum 80 CRI.
- ▶ Efficacies up to 113 lm/W.
- ▶ Designed for use in pairs to asymmetrically illuminate patient beds.
- ▶ Fixtures can be installed to allow maintenance access without working directly over patient beds.
- ▶ Double-gasketed sani-shield protects fixture from dust, bugs and other contaminants while simplifying maintenance and cleaning.
- ▶ Anti-microbial white finish standard.
- ▶ This fixture is proudly made in the USA.

## SYSTEM REQUIREMENTS

- Lighting system (site software)
- Gateway or alternate server (runs software)
- PoE switches or Ethernet switches and mid-span power injectors
- See [hew.com/poe](http://hew.com/poe) for details

## CONFIGURATIONS

STYLE	DESCRIPTION	CONFIGURATION	LUMENS		TOTAL WATTAGE
			AMBIENT	EXAM	
<b>AMBIENT ONLY – EXAMPLE: P45/840</b>					
<b>4A</b>	Single fixture, ambient only		<b>P45/</b> = 4,500	–	46
<b>4 + 4A</b>	Pair of fixtures, ambient only		<b>P90/</b> = 9,000	–	92
<b>AMBIENT &amp; EXAM – EXAMPLE: P30/P80/840</b>					
<b>4AE</b>	Single fixture, ambient & exam		<b>P15/</b> = 1,500	<b>P40/</b> = 4,000	49
<b>4 + 4AE</b>	Pair of fixtures, ambient & exam		<b>P30/</b> = 3,000	<b>P80</b> = 8,000	97
<b>EXAM ONLY – EXAMPLE: P50/840</b>					
<b>4E</b>	Single fixture, exam only		–	<b>P50/</b> = 5,000	46
<b>4 + 4E</b>	Pair of fixtures, exam only		–	<b>P100</b> = 10,000	91

Nominal lumen output based on 4000K for single CCT and TW. Actual lumens may vary +/-5%, see fixture performance data.



# MD4

tunable **WHITE** | PoE

# DUAL FUNCTION MEDICAL BED LIGHT

## SPECIFICATIONS

**Housing** – 20-gauge die-formed and welded C.R.S.

**Door Frame** – .050" extruded regressed aluminum frame with curved diffuse acrylic lens and clear acrylic sani-shield. T-slot steel hinge allows reversible hinging and latching. Fully enclosed spring-loaded cam latches

**Shielding** – Internal curved diffuse ribbed acrylic with external clear, non-prismatic sani-shield lens

**Finish** – 92% minimum average reflective white anti-microbial powder coat, bonded to phosphate-free, multi-stage pretreated metal. All parts painted after fabrication to facilitate installation, increase efficiency, and inhibit corrosion.

**Electrical** – High quality mid-power LED board. L70 > 50,000 hours per IES TM-21. Low-voltage DC fixture, to be fed by Class 2 power supply. Tunable White products use LEDs of multiple CCTs and may produce a perceptibly different shade of white from single-CCT products at the same CCT. All CCTs are within 3 MacAdam ellipses.

**Mounting** – NEMA Type "G" standard. For flange installations use the Drywall Kit (DFK), ordered separately. Fixture must be installed prior to Drywall Kit (DFK). Accommodates "NFG" and "SG" without modification (earthquake clips required).

**Labels** – cCSAus certified as luminaire suitable for dry or damp locations.

**Warranty** – 5-year limited warranty, see [hew.com/warranty](http://hew.com/warranty).

## IMPORTANT:

Electrostatic sensitive unit. Observe precautions when handling.

## FIXTURE PERFORMANCE DATA

### STANDARD

STYLE	LED PACKAGE		TOTAL DELIVERED LUMENS	TOTAL WATTAGE	EFFICACY (lm/W)
	AMB	EXAM			
4A	P45	–	4518	46.0	98.2
4+4A <sup>1</sup>	P90	–	9036	92.0	98.2
4AE	P15	P40	5514	48.6	113.4
4+4AE <sup>1</sup>	P30	P80	11028	97.3	113.4
4E	–	P50	5038	45.5	110.7
4+4E <sup>1</sup>	–	P100	10076	91.0	110.7

<sup>1</sup> Fixture contains two nodes, one power drop per node required.  
<sup>2</sup> Fixture contains three nodes, one power drop per node required.

### TUNABLE WHITE

STYLE	LED PACKAGE		TOTAL DELIVERED LUMENS	TOTAL WATTAGE	EFFICACY (lm/W)
	AMB	EXAM			
4A	P45	–	4528	48.5	93.5
4+4A <sup>1</sup>	P90	–	9056	96.9	93.5
4AE <sup>1</sup>	P15	P40	5514	50.8	108.6
4+4AE <sup>2</sup>	P30	P80	11026	101.5	108.6

## MULTIPLIER TABLES

### STANDARD

CCT	CONVERSION FACTOR
2700K	0.94
3000K	0.96
3500K	0.97
4000K	1.00
5000K	1.03

### TUNABLE WHITE

CCT	CONVERSION FACTOR
3000K	0.95
3500K	0.98
4000K	1.00
5000K	0.96

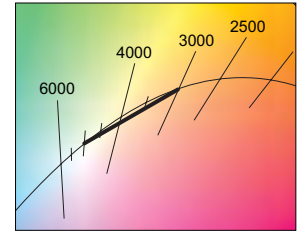

- Photometrics tested in accordance with IESNA LM-79. Results shown are based on 25°C ambient temperature.
- Standard results based on 4000K standard, 80 CRI, actual lumens may vary +/-5%
- Tunable white results based on 4000K standard, 80 CRI, actual lumens may vary +/-5%
- Use multiplier table to calculate additional options.

## PHOTOMETRY

**MD4AG-P45/840-A-PoE Ambient only** Report #: 20051.0; 09/26/17 | Total Luminaire Output: 4518 lumens; 46 Watts | Efficacy: 98 lm/W

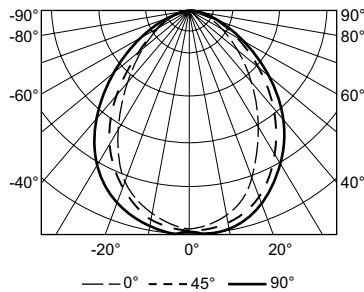

Vertical Angle	Horizontal Angle					Zonal Lumens
	0°	45°	90°	135°	180°	
0	2345	2345	2345	2345	2345	
5	2305	2347	2380	2331	2311	222
15	2118	2236	2307	2193	2142	623
25	1729	1976	2084	1917	1767	885
35	1281	1609	1763	1461	1265	949
45	896	1174	1301	963	790	832
55	574	758	805	511	416	594
65	239	387	422	213	128	312
75	55	97	154	30	24	93
85	0	4	12	2	2	9
90	0	0	0	0	0	

LUMEN SUMMARY	Zone	Lumens	% Fixture
	0 - 30	1730	38
	0 - 60	4104	91
	0 - 90	4518	100
0 - 180	4518	100	

**MD4EG-P50/840-A-PoE Exam only** Report #: 20050.0; 09/26/17 | Total Luminaire Output: 5038 lumens; 45.5 Watts | Efficacy: 111 lm/W

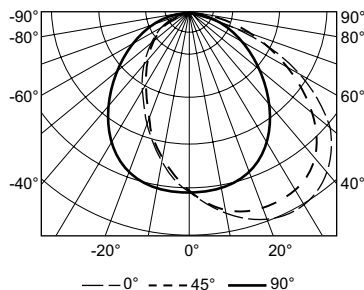

Vertical Angle	Horizontal Angle					Zonal Lumens
	0°	45°	90°	135°	180°	
0	1936	1936	1936	1936	1936	
5	2075	2045	1963	1782	1842	183
15	2299	2210	1908	1479	1466	525
25	2411	2257	1764	1155	1082	797
35	2375	2174	1527	883	775	964
45	2166	1911	1230	636	533	993
55	1683	1482	844	399	363	850
65	827	929	478	212	180	534
75	171	277	164	53	52	180
85	0	3	3	2	3	13
90	0	0	0	0	0	

LUMEN SUMMARY	Zone	Lumens	% Fixture
	0 - 30	1505	30
	0 - 60	4312	86
	0 - 90	5038	100
0 - 180	5038	100	

**MD4AEG-P15/P40/840-A-PoE Ambient & Exam** Total Luminaire Output: 5514 lumens; 48.6 Watts | Efficacy: 113 lm/W

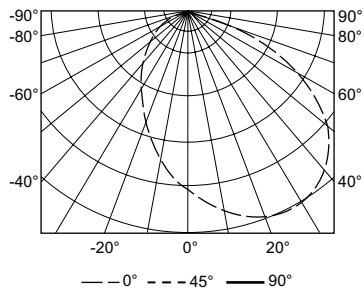

Vertical Angle	Horizontal Angle					Zonal Lumens
	0°	45°	90°	135°	180°	
0	2293	2293	2293	2293	2293	
5	2390	2392	2338	2176	2221	218
15	2454	2458	2300	1949	1859	623
25	2352	2392	2141	1604	1432	923
35	2151	2180	1855	1236	1040	1069
45	1849	1834	1487	851	700	1049
55	1431	1422	1033	547	444	875
65	764	929	638	274	177	555
75	161	327	216	50	42	188
85	4	6	9	0	3	14
90	0	0	0	0	0	

LUMEN SUMMARY	Zone	Lumens	% Fixture
	0 - 30	1764	32
	0 - 60	4757	86
	0 - 90	5514	100
0 - 180	5514	100	



## FIXTURE DETAILS

### BACK VIEW

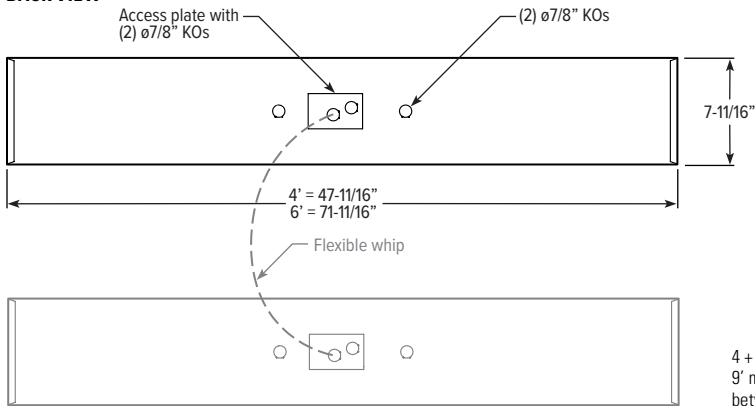

4 + 4 combinations supplied with 9' master/satellite flexible whip between fixtures.

### REMOTE MOUNT EM OPTION DETAILS

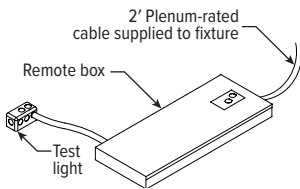

Includes 2' plenum rated 18ga. solid cable. Remote box can be installed in:

- Above ceiling grid
- Remote closet (within 100ft)
- Surface below ceiling

See [Technical Info](#) for dimension details.

## GASKETING DETAILS

### DOUBLE GASKETING (STANDARD)

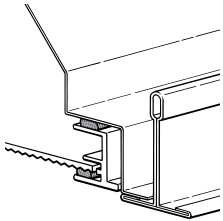

Gasketing is factory-installed continuously between door frame and luminaire housing; and between door frame and lens.

### TRIPLE GASKETING (TG)

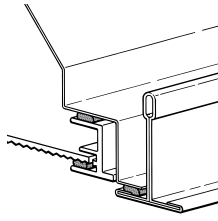

Gasketing is field-installed continuously between door frame and luminaire housing; and between door frame and lens. Gasketing between bottom perimeter of unit (adjacent to T-bar or hardpan ceiling) is provided by factory and field installed.

