

# MX4UD PoE | tunable **WHITE** 4" Continuous Up/Down – Suspended

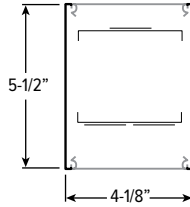

CATALOG #: \_\_\_\_\_

TYPE: \_\_\_\_\_

PROJECT: \_\_\_\_\_

## FEATURES

- Williams turn-key Power over Ethernet (PoE) solution provides plug-and-play networked lighting and control
- Tunable white from 3000K to 5000K CCT, minimum 80 CRI
- Create elegant spaces with a seamless, continuous row of illumination
- Flat and proud lenses give designers a variety of looks
- Moveable mounting hardware easily slides along the length of the fixture providing variable mounting points
- Maximize energy savings with efficacies as high as 130 lm/W
- Linear extrusion contains snap-in light rails for ease of installation and maintenance
- Versatile MX4 system includes recessed, surface, suspended and in-wall mounting, see [hew.com](http://hew.com)
- Corner configurations available, see Product Builder at [hew.com/product-builder](http://hew.com/product-builder)
- Made Right Here™ in the USA

## SYSTEM REQUIREMENTS

- Lighting system (site software)
- Gateway or alternate server (runs software)
- PoE switches or Ethernet switches and mid-span power injectors
- See [hew.com/poe](http://hew.com/poe) for details

## SPECIFICATIONS

- HOUSING** – Extruded aluminum with die-cast end plates.
- SHIELDING** – Extruded, flat, diffuse acrylic lens.
- FINISH** – Textured matte white polyester TGIC powder coat bonded to phosphate-free, multi-stage pretreated metal. All parts painted after fabrication to facilitate installation, increase efficiency, and inhibit corrosion.
- ELECTRICAL** – High quality mid-power LED board. L70 > 60,000 hours per IES TM-21. Low-voltage DC fixture, to be fed by Class 2 power supply. Tunable White products use LEDs of multiple CCTs and may produce a perceptibly different shade of white from single-CCT products at the same CCT. All CCTs are within 3 MacAdam ellipses.
- MOUNTING** – Suspended. 1/16" diameter adjustable steel leveling aircraft cable and mounting hardware necessary for grid and hardpan ceiling applications provided.
- LISTINGS** – cETLus conforms to UL STD 1598. Certified to CAN/CSA STD C22.2 No. 250.0. Suitable for damp locations.
- WARRANTY** – 5-year limited warranty, see [hew.com/warranty](http://hew.com/warranty).

## ORDERING EXAMPLE: MX4UD - 12'00 - P7/835U/P7/835D - A/F - AC/D48 - OPTIONS - POE N

### SERIES LENGTH

**MX4UD** Lengths specified in feet and inches using 4" increments, 2' minimum.  
Example: 12'00 = 12'-0"

### Product Builder

Easily build shapes & simplify ordering with the Williams Linear Product Builder at [hew.com/product-builder](http://hew.com/product-builder) <sup>[1]</sup>



### LUMEN PACKAGE (EXAMPLE: P7/835U/P7/835D)

Specify lumen packages: U for Uplight and D for Downlight

LUMENS <sup>[4]</sup>	CRI	CCT	U or D
P7 700lm	8 80	27 2700K	U Uplight
	9 90 <sup>[5]</sup>	30 3000K	D Downlight
		35 3500K	
		40 4000K	
		50 5000K	
		TW Tunable white (80 CRI, 3000K–5000K)	

### SHIELDING UP

**A** Flat, semi-diffuse acrylic  
**F** Flat, diffuse acrylic <sup>[2]</sup>

### SHIELDING DOWN

**F** Flat, diffuse acrylic  
**P** Proud, diffuse acrylic with 5/16" drop <sup>[3]</sup>

### MOUNTING (EXAMPLE: AC/D48) <sup>[6]</sup>

Prefix	Type	Length
AC/	D 1" grid & hardpan	24 24" 48 48"
	N 9/16" grid	96 96"
	S Slot grid	

### OPTIONS <sup>[7]</sup>

**EM/CP12** Remote mount 12-watt lota emergency battery <sup>[9]</sup>

### CONTROL <sup>[8]</sup>

**POE N** Power over Ethernet network node  
**POE D** Power over Ethernet device node <sup>[10]</sup>

## NOTES

- See page 3 for CORNER DETAILS.
- Recommended for use in applications where fixture will be viewed from above. Decreases lumen output.
- See page 3 for SHIELDING DETAILS. Not available with corner configurations.
- Nominal lumens per foot output based on F shielding and 3500K for single CCT and 4000K for TW. Actual lumens may vary ±5%. See page 2 for FIXTURE PERFORMANCE DATA.
- Extended lead times may apply. Consult factory for availability. Not available with Tunable White
- See page 2 for MOUNTING DETAILS.
- See page 3 for FINISH OPTIONS. Custom colors available upon request. See [hew.com/poe](http://hew.com/poe) for compatible sensors and switches.
- For additional PoE info, see [hew.com/poe](http://hew.com/poe).
- Requires one additional category cable run to switch. See page 3 for REMOTE MOUNT DETAILS.
- Not available with fixtures over 40W.



# MX4UD PoE | tunable WHITE

## 4" Continuous Up/Down – Suspended

### FIXTURE PERFORMANCE DATA

#### STANDARD (PER FOOT)

DELIVERED LUMENS	WATTAGE	EFFICACY (lm/W)
1435	12	123

#### TUNABLE WHITE (PER FOOT)

DELIVERED LUMENS	WATTAGE	EFFICACY (lm/W)
1427	11	130

- Photometrics tested in accordance with IESNA LM-79. Results shown are based on 25°C ambient temperature.
- Standard results based on 3500K standard, 80 CRI, actual lumens may vary ±5%.
- Tunable white results based on 4000K standard, 80 CRI, actual lumens may vary ±5%.
- Use multiplier tables to calculate additional options.

#### MULTIPLIER TABLES

	STANDARD	
	COLOR TEMPERATURE	
	CCT	CONVERSION FACTOR
80 CRI	2700K	0.97
	3000K	0.99
	3500K	1.00
	4000K	1.03
	5000K	1.06

90 CRI	2700K	0.82
	3000K	0.83
	3500K	0.84
	4000K	0.86
	5000K	0.90

TUNABLE WHITE	
COLOR TEMPERATURE	
CCT	CONVERSION FACTOR
3000K	0.95
3500K	0.98
4000K	1.00
5000K	0.96

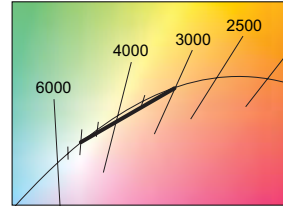

### PHOTOMETRY

MX4WUD-4'00-P7/835U/P7/835D-A/F Total Luminaire Output: 5740 lumens; 46.8 Watts | Efficacy: 123 lm/W | 80 CRI; 3500K CCT

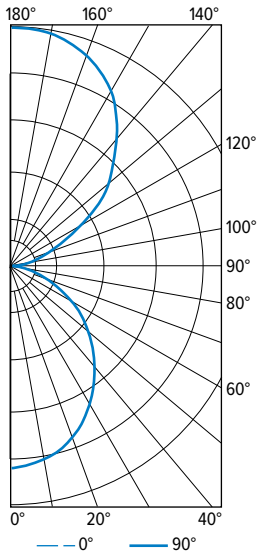

VERTICAL ANGLE	HORIZONTAL ANGLE					ZONAL LUMENS
	0°	45°	90°	135°	180°	
0	985	985	985	985	985	
5	1002	992	968	966	976	93
15	957	949	930	916	921	263
25	875	868	839	830	830	390
35	750	745	722	707	700	453
45	604	602	582	568	540	448
55	455	444	424	417	412	383
65	288	281	271	266	266	271
75	137	130	124	127	120	137
85	24	21	15	19	21	30
90	5	5	10	5	5	
95	50	58	60	53	48	61
105	172	185	187	168	148	189
115	341	364	381	336	307	350
125	558	576	594	544	508	506
135	799	808	810	772	734	607
145	980	983	990	945	925	606
155	1110	1113	1119	1082	1062	507
165	1177	1180	1192	1160	1146	331
175	1191	1196	1218	1185	1168	114
180	1192	1192	1192	1192	1192	

	ZONE	LUMENS	% FIXTURE
LUMEN SUMMARY	0 - 30	746	13
	0 - 40	1198	21
	0 - 60	2029	35
	0 - 90	2468	43
	90 - 120	601	11
	90 - 130	1107	19
	90 - 150	2320	40
	90 - 180	3272	57
	0 - 180	5740	100

### MOUNTING DETAILS

#### INDIRECT HANGER DETAILS

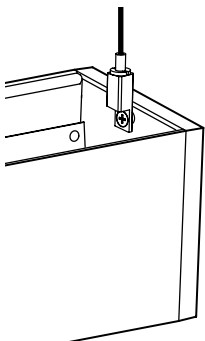

Standalone hanger

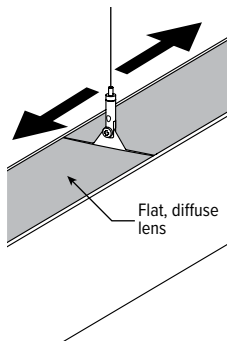

Joiner hanger can slide to any position along the extrusion. Lens may be cut to fit around the hanger as needed.

#### STANDARD HARDWARE

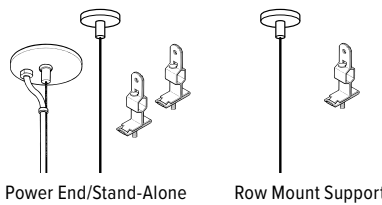

Power End/Stand-Alone

Row Mount Support

#### Notes:

- Fixtures are provided with adjustable length aircraft cables and mounting hardware, must specify.
- Electrical supply is brought into the feeder (or stand-alone) fixture, either as part of a row or as an individual mount unit. Power feed locations are at end of fixture.
- One 5" canopy included for each feeder fixture. One 2" canopy included for each additional fixture required in a row.



# MX4UD PoE | tunable **WHITE** 4" Continuous Up/Down – Suspended

## SHIELDING DETAILS

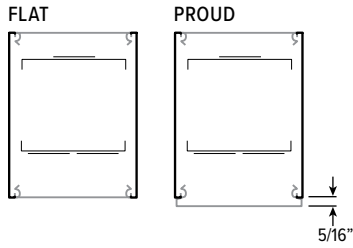

## FINISH OPTIONS

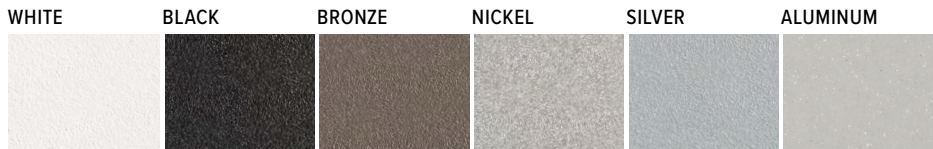

For custom color, please specify RAL code or a manufacturer code with description. All custom colors other than RAL require two sample swatches, minimum 1" square.

## REMOTE MOUNT DETAILS

Includes 2' plenum-rated 18ga. solid cable. Remote box can be installed in:

- Above ceiling grid
- Remote closet (within 100ft)
- Surface below ceiling

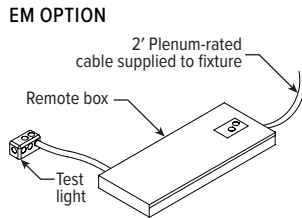

## CORNER DETAILS

### BACK VIEW

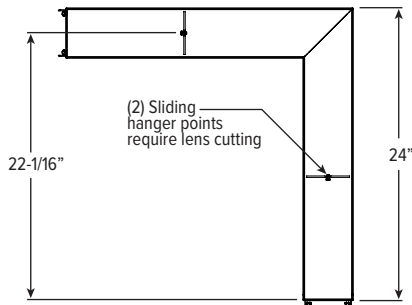

Note: Corner orientation determined in field. Feeder corner end cap shipped separately.

