

MX4WUD LED 4" Continuous Up/Down – Wall

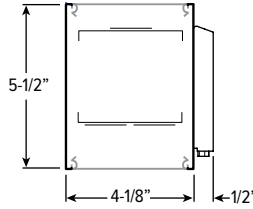
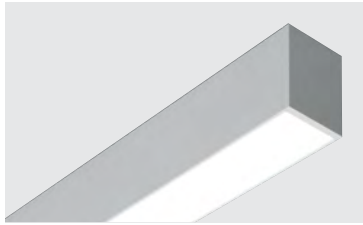

CATALOG #: _____

TYPE: _____

PROJECT: _____

FEATURES

- Create elegant spaces with a seamless, continuous row of illumination
- Flat and proud lenses give designers a variety of looks
- Fixture attaches to wall bracket for simple installation
- Maximize energy savings with efficacies as high as 119 lm/W
- Linear extrusion contains snap-in light rails for ease of installation and maintenance
- Versatile MX4 system includes recessed, surface, suspended and in-wall mounting, see hew.com
- Diffuse acrylic lens provides uniform illumination for visual comfort
- Made Right Here® in the USA

SPECIFICATIONS

- HOUSING – Extruded aluminum with die-cast end plates.
- SHIELDING – Extruded, flat, diffuse acrylic lens.
- FINISH – Textured matte white polyester TGIC powder coat bonded to phosphate-free, multi-stage pretreated metal. All parts painted after fabrication to facilitate installation, increase efficiency, and inhibit corrosion.
- ELECTRICAL – High quality mid-power LED boards. L70 >60,000 hours per IES TM-21. 25°C maximum ambient operating temperature
- MOUNTING – Wall mount. Powder coated, die-formed C.R.S. receiving bracket mounted to fixture which attaches to galvanized, wall mounted bracket.
- LISTINGS –
 - cETLus conforms to UL STD 1598. Certified to CAN/CSA STD C22.2 No. 250.0. Suitable for damp locations.
 - DesignLights Consortium qualified product. Not all versions of this product may be DLC qualified, see the DLC Qualified Products List at www.designlights.org/QPL.
- WARRANTY – 5-year limited warranty, see hew.com/warranty.

ORDERING EXAMPLE: MX4WUD - 12'00 - L8/835U/L8/835D - A/F - OPTIONS - DIM - UNV

SERIES	LENGTH	LUMEN PACKAGE (EXAMPLE: L8/835U/L8/835D)			
MX4WUD	Lengths specified in feet and inches using 4" increments, 2" minimum. Example: 12'00 = 12'-0"	Specify lumen packages: U for Uplight and D for Downlight			
	PRODUCT BUILDER Simplify ordering & layout design with the Williams Linear Product Builder at hew.com/product-builder	LUMENS ^[1]	CRI	CCT	U or D
		L8 800lm	8 80	27 2700K	U Uplight
		L12 1200lm	9 90 ^[2]	30 3000K	D Downlight
		L15 1500lm		35 3500K	
				40 4000K	
				50 5000K	

SHIELDING UP	SHIELDING DOWN	OPTIONS ^[3]	
A Flat, semi-diffuse acrylic	F Flat, diffuse acrylic	EM/7WRM	Remote mount 7-watt emergency battery ^[6]
F Flat, diffuse acrylic ^[4]	P Proud, diffuse acrylic with 5/16" drop ^[5]	EM/10WRM	Remote mount 10-watt emergency battery ^[7]
		OCC__	Factory-installed occupancy sensor ^[8] ; OCCWS FS-355-L6

DRIVER ^[9]	VOLTAGE
DIM Entire fixture switches and dims together	120 120V 277 277V
DRV Non dimming, entire fixture switches together	UNV 120-277V 347 347V ^[10]

NOTES

- ¹ Lumens per foot output based on 3500K CCT and F shielding. Actual lumens may vary ± 5%. See page 2 for FIXTURE PERFORMANCE DATA.
- ² Extended lead times may apply. Consult factory for availability.
- ³ See page 3 for FINISH OPTIONS. Custom colors available upon request. See Technical Info for [Power Entry](#) details.
- ⁴ Recommended for use in applications where the fixture will be viewed from above. Decreases lumen output.
- ⁵ See page 3 for SHIELDING DETAILS.
- ⁶ 120-277V only.
- ⁷ 120-277V only.
- ⁸ Recommended for use in downlight orientation only. Utilizes 4" of housing at end of fixture. See page 3 for FIXTURE DETAILS. 120V or 277V only.
- ⁹ See page 2 for ADDITIONAL DRIVER OPTIONS.
- ¹⁰ Not available with EM drivers.



MX4WUD LED 4" Continuous Up/Down – Wall

FIXTURE PERFORMANCE DATA

	PER FOOT		
	DELIVERED LUMENS	WATTAGE	EFFICACY (lm/W)
L8	1683	14.2	119
L12	2370	21.9	108
L15	2885	27.6	105

- Photometrics tested in accordance with IESNA LM-79. Results shown are based on 25°C ambient temperature.
- Wattage shown is average for 120V through 277V input.
- Results based on F shielding for Down compartment and A shielding for Up compartment, 3500K, 80 CRI, actual lumens may vary +/-5%
- Use multiplier table to calculate additional options.

MULTIPLIER TABLE

	COLOR TEMPERATURE	
	CCT	CONVERSION FACTOR
80 CRI	2700K	0.97
	3000K	0.99
	3500K	1.00
	4000K	1.03
	5000K	1.06
90 CRI	2700K	0.82
	3000K	0.83
	3500K	0.84
	4000K	0.86
	5000K	0.90

PHOTOMETRY

MX4WUD-4*00-L8/835U/L8/835D-A/F-DIM Total Luminaire Output: 6732 lumens; 56.8 Watts | Efficacy: 119 lm/W | 80 CRI; 3500K CCT

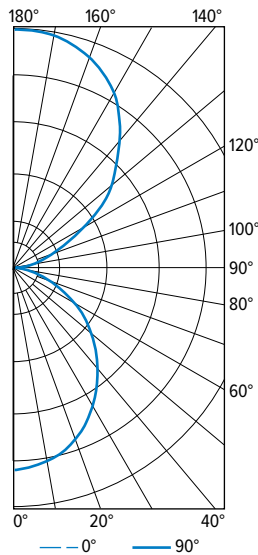

VERTICAL ANGLE	HORIZONTAL ANGLE					ZONAL LUMENS
	0°	45°	90°	135°	180°	
0	1155	1155	1155	1155	1155	
5	1175	1163	1135	1133	1145	109
15	1123	1113	1091	1075	1081	309
25	1026	1018	984	974	974	457
35	879	873	847	829	821	531
45	708	706	682	666	634	526
55	533	521	497	489	483	449
65	338	330	318	312	312	318
75	161	153	145	149	141	161
85	28	24	18	22	24	36
90	6	6	12	6	6	
95	58	68	70	62	56	71
105	201	217	219	197	173	222
115	400	427	447	394	360	411
125	654	676	696	638	596	594
135	938	948	950	905	861	712
145	1149	1153	1161	1109	1085	711
155	1302	1306	1312	1270	1246	595
165	1380	1384	1398	1360	1344	388
175	1396	1403	1429	1390	1370	133
180	1398	1398	1398	1398	1398	

LUMEN SUMMARY	ZONE	LUMENS	% FIXTURE
	0 - 30	875	13
0 - 40	1406	21	
0 - 60	2380	35	
0 - 90	2894	43	
90 - 120	704	11	
90 - 130	1298	19	
90 - 150	2721	40	
90 - 180	3838	57	
0 - 180	6732	100	

ADDITIONAL DRIVER OPTIONS

Note: Lumen restrictions apply, consult product builder at hew.com/product-builder.

CATALOG NUMBER	DESCRIPTION
DRV	Driver prewired for non-dimming applications; entire fixture switches together
DIM	Dimming driver prewired for 0-10V low voltage applications; entire fixture switches and dims together
DRVU/DRVD	Driver prewired for non-dimming applications; up and down portions switch separately
DRVU/DIMD	Driver prewired for non-dimming applications; up and down portions switch separately; 0-10V on down portion only
DIMU/DRVD	Up and down portions switch separately; dimming driver prewired for 0-10V low voltage applications on up portion only
DIMU/DIMD	Dimming driver prewired for 0-10V low voltage applications; up and down portions switch and dim separately
DRVDIMU	Entire fixture switches together; dimming driver prewired for 0-10V low voltage applications on up portion only
DRVDIMD	Entire fixture switches together; dimming driver prewired for 0-10V low voltage applications on down portion only
DIM1	1% dimming driver prewired for 0-10V low voltage applications
DIM LINE	Line voltage dimming driver (Must specify 120V or 277V only)
DIM LINEU/DIM LINED	Line voltage switching and line voltage dimming; up and down portions switch separately
DIM LINEU/DRVD	Up and down portions switch separately; line voltage dimming on up portion only
DRVU/DIM LINED	Up and down portions switch separately; line voltage dimming on down portion only



MX4WUD LED 4" Continuous Up/Down – Wall

MOUNTING DETAILS

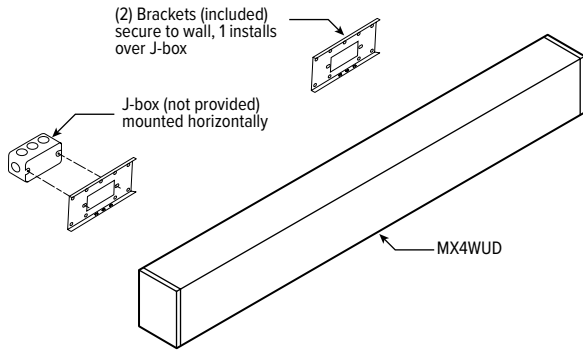

FIXTURE DETAILS

BACK VIEW

Standalone and feeder fixtures receive two mounting brackets. Joiner fixtures connect to feeder fixtures and receive one mounting bracket.

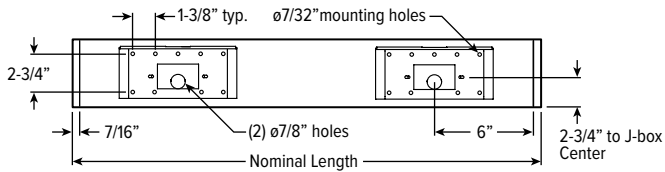

OCCUPANCY SENSOR



SHIELDING DETAILS

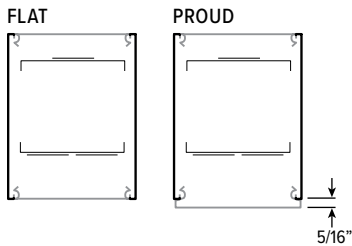

FINISH OPTIONS

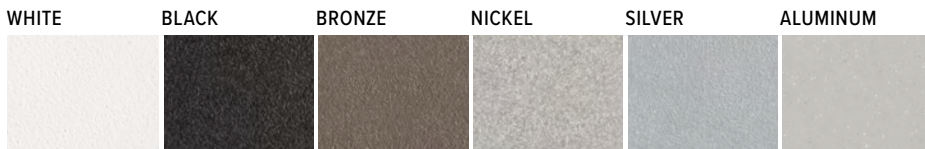

For custom color, please specify RAL code or a manufacturer code with description. All custom colors other than RAL require two sample swatches, minimum 1" square.

